



**rlh**  
**HAUPTNER**  
*Herberholz*

**Animal identification**  
**Stock Breeding equipment**  
**Veterinary instruments**



Since 1857 we have been successfully working in the stock breeding, animal identification and veterinary instruments sectors. With a product range of over 4.500 products, we are a very diverse company acting all over the world. As a result we own the following core competences, which has allowed us more than 150 years success in the markets and enabled us to make the difference to you as our customer:

### **Quality**

Quality has been an essential part of our behaviour since our foundation. „Made in Germany“ is not just a commitment to our roots. Daily, we are trying to fulfill this seal of quality in everything we are doing. Our ISO-certification is one of our proofs for the expectation of quality.

### **Reliability**

Against the background of our long-time existence and our tradition you can see, that today and at that time reliability was and is an implicitness for us. It is an important part of respectful interaction between people.

### **Technology**

Our tradition obliges us as well to straighten our look into the future and to work daily on innovative solutions. In close cooperation with users we are permanently developing new products.



Since September 2001 Hauptner and Herberholz have been certified according to the international guidelines (DIN ISO 9001:2008) and was and will be controlled annually by an external auditor.

© **H. Hauptner und Richard Herberholz GmbH & Co. KG, Solingen**

All rights reserved. No part of this publication may be reproduced, stored in a retrieval system or transmitted in any form or by any means, electronic, mechanical, photocopying, recording or otherwise without written permission.

# Contents

<b>Veterinary instruments</b>	
Diagnostic instruments	7-11
Surgical and anatomic instruments, Meat inspection equipment	12-38
Syringes, Needles and Blood taking instruments	39-59
Heat detector, Insemination instruments, Ultrasound units, Obstetric instruments	60-81
Sexual organ instruments, Catheters, Instruments for oesophagus and stomach	82-91
Clinic equipment	92-97
<b>Stock Breeding equipment</b>	
Restraining equipment, Castration instruments, Dehorning, Hoof and Claw instruments, Teat and Dental instruments	98-121
Clippers and Accessories, Hair scissors	122-134
Livestock-Breeding equipment, Farm equipment	135-144
<b>Animal identification</b>	
Plastic ear tags, Electronic animal identification,...	145
Brass ear tags, License plates, Ear-marking pliers	146-149
Marking hammers and Accessories	150-151
Tattooing pliers and Accessories, Freeze branding, Marking spray and sticks	152-157
<b>Index</b>	<b>158-161</b>
<b>Conditions of payment and delivery</b>	<b>162</b>

## Concentrated competence for your advantage!

Today's markets require from their participants fast reactions to the demanded expectations and wishes. We are facing up to this challenge with consequent assistance and an optimally composed manufacturing and delivery programme.



Company building Kuller Straße, Solingen

## We maintain and repair your high-quality Hauptner and Herberholz - products!

Even many years later, you can still order spare parts for our original products. In many cases, expensive instruments only become unusable because of the wearing parts. You can be confident that these products will regain their functional value thanks to spare part replacement and professional installation.



Products with the S-Line symbol are part of our economic alternative product range.

## Percussion hammers

### **Percussion hammer, small**

100 g, 17 cm long, stainless

00510.000

### **Spare rubber**

00510.060



### **Percussion hammer, medium**

145 g, 19 cm long, stainless, with wooden handle

00530.000

### **Spare rubber**

00530.060



### **Percussion hammer, large**

190 g, 19 cm long, stainless, with wooden handle

00540.000

### **Spare rubber**

00530.060



### **Percussion hammer, simple**

70 g, 20 cm long, stainless

00560.000



The percussion hammers are used for testing the reflexes of the joints and organs like the lungs, the heart or the stomach. With the hammer you hit the part of the body where you want to do the examination. From the resonance of the different tones your diagnosis is supported.

## Pleximeter

### **Pleximeter**

for large and small animals, 5,0 x 2,8 cm, stainless

00710.000



### **Pleximeter**

for large animals, 18,5 x 1,5 cm, stainless

00810.000



### **Pleximeter**

for large animals, 15 x 2,5 cm, stainless

00910.000



The plessimeter is a helping instrument that is used in the diagnostic. The echo caused by the percussion hammer will be enforced. This will be helpful in hearing and distinguishing the different tones. It consists of a thin, spatula-shaped plate, which has to be pressed tightly onto the part of the body which will be examined. The advantage of the plessimeter is that the generated echo will be louder compared to the direct percussion and the fingers of the operator will be preserved.

## Thermometer

### **Veterinarian thermometer**

with fastening knob, without quicksilver, measurement period: 60 sec.

00152.000

### **Digital thermometer „digi-vet 35-3“**

with fastening knob, waterproof, 3-digit display, signal tone, memory of temperature, measurement period: 10 s.

00191.000

### **Digital thermometer „digi-vet19flex“**

with short flexible measuring tip, measurement period: 10 sec., for small animals

00192.000

### **Digital thermometer**

with signal tone and memory of temperature, waterproof, 14,5 cm long, measurement period: 10 sec.

00195.000

### **Digital thermometer SC 12**

especially for cattle, horses and pigs, long temperature sensor, quick temperature measurement, waterproof, can be disinfected, measurement period: 15-25 sec.

00196.000



## Foreign body detector

### **Ferroscope 3**

Transistor type for putting on, for localisation of metallic foreign bodies inside the animal, optical and acoustical indication through a scale and headphone, including carrying case and 4 batteries 1,5 volt, 1,54 kg, long-lasting

39500.000

Cows can easily eat ferro-magnetic bodies together with their food. These parts will enter into the stomach and could stick in the stomach walls, causing pain and infections. The clinical picture is very similar to bronchitis. For getting a clear diagnosis of the foreign bodies the Ferroscope 3 is required. The ferroscope 3 is a high precision special instrument, for detecting covered magnetic and non-magnetic metal parts. Magnetic parts can be detected already from a larger distance, depending on their size, whereas non-magnetic metal parts (like copper, aluminium or brass) can be detected from a short distance only. The Ferroscope 3 consists of 3 parts, the probe, the indication unit and the ear phone with cable.

First of all the unit has to be adjusted, this means turning the regulating ring at the probe till the sensitivity shows „0“ on the scale. At the same moment the acoustic indication will be automatically adjusted to the lowest level. Now you can examine the cow by guiding the probe along the flanks of the animal and under the animal's body, close to the skin. Do not forget that the probe has to be connected by cable with the main unit which you can hang around your neck and the ear phone is connected as well to the main unit. During the examination, please guide the probe in a way, that at least one of the marking points at the upper end of the probe has contact with the animal's body. When approaching metal foreign bodies the tone in the ear phone becomes louder and the pointer at the scale moves further. By guiding the probe in longitudinal direction and crosswise the exact position of the foreign body can be localised.

## Stethoscopes

### **Goetze's stethoscope**

with red rubber tubing length 85 cm (35 cm + 2x 25 cm) and metal membrane 65 mm Ø, top quality, weight only 296 g, for large animals

01220.000



### **Spare parts:**

#### **Chest piece adapter**

01220.140

#### **Y-piece**

01220.050

#### **Ear piece, single**

01220.130

#### **Chest piece**

nickel-chrome-plated

01220.200

#### **Head bow**

nickel-plated

01220.210

#### **Rubber tubing**

red, inner-Ø 7 mm, Outside-Ø 10 mm, for stethoscope 01220.000, per meter

24410.000



### **Funnel-Stethoscope**

with flexible rubber, bell shaped chest piece 50 mm Ø, lateral leads, with plastic tubing, 212 g

01241.000

### **Spare-double-plastic-tubing**

75 cm, Inner-Ø 6 mm, Outside-Ø 9 mm

01230.300



### **Reversible stethoscope**

(as Rappaport) with rubber tubing, with massive metal head, membranes 45 mm Ø and 30 mm Ø, strong quality, weight 218 g, for small and large animals

01270.000

### **Stethoscope**

as 01270.000 with rubber tubing 80 cm

01270.800

### **Spare rubber tubing**

for stethoscope 01270.000, pair, 50 cm long, Inner-Ø 6 mm, Outside-Ø 9 mm

01270.010

### **Extension set**

for 01270.000 for extension from 40 cm to 60 cm

01270.030

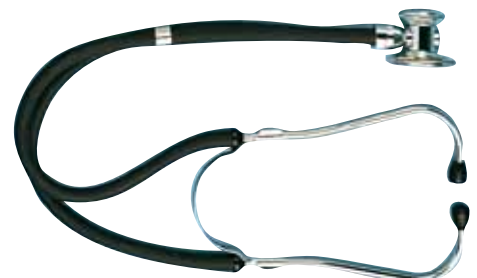



## Specula

### **Speculum**

for aural, vaginal and rectal inspection, jaw 32 mm, stainless for small animals

01521.000



### **Kilian's speculum**

jaw 90 mm, stainless, for small animals

01524.000



## Foreign body forceps

### **Hartmann's foreign body forceps**

extra fine, suitable for otoscope funnels over 2,5 mm Ø, working length ca. 14 cm, jaw 10 mm, stainless

**SLine** 97080

01532.000



### **Buck's foreign body lever**

working length 11 cm, jaw 8 mm, stainless

**SLine** 97081

01535.000



### **Tic forceps**

for easy removal of tics, made of plastic, 9,5 cm

01539.000



### **Dressing holder**

17 cm, 2 mm Ø, stainless

01527.000

## Pocket diagnostic instruments



### **Otoscope**

consisting of battery handle, set of tips (2, 3 und 4 mm Ø), without batteries, swivel loupe, continuously-variable brightness control

68710.000

### **1 Set of tips**

2, 3 und 4 mm Ø

68710.010

### **Spare lamp**

2,5 V

42960.030



## Otoscope-Set

### Otoscope-Set VET 1

high-quality instruments with fiber optics and halogene lighting 2,5 V complete with battery handle, operation otoscope, ophthalmoscope, nose speculum, earfunnel, made of metal (2x slit and 2x closed) and tongue depressor

01547.000



## Accessories

Battery handle type C, Ø 28 mm, ri-scope®

01547.010



ri-scope® operation otoscope head veterinary  
HL 2,5 V

01547.030



ri-scope® ophthalmoscope head HL 2,5 V

01547.400



ri-scope® nose speculum HL 2,5 V

01547.500



ri-scope® tongue depressor HL 2,5 V

01547.600



Re-usable ear funnel, slit

Ø 7,5 mm, length 68 mm

01547.070

Ø 9,4 mm, length 92 mm

01547.080



Re-usable ear funnel, closed

Ø 4 mm, length 82 mm

01547.040

Ø 5 mm, length 52 mm

01547.050

Ø 6 mm, length 82 mm

01547.060



With this otoscope set examinations of ear, nose, vagina and rectum are possible. The bright light of the halogene lighting enables an optimal view on the examination field.

## Probes



### **Round ended probe**

15 cm, stainless

Ø 2 mm

06352.000

Ø 3 mm

06351.000

### **Grooved director**

14,5 cm, stainless

06471.000

## Retractors



### **Retractor, double**

sharp, 20 cm, stainless

**SLine** 97385

06790.000



### **Retractor, four-pronged**

blunt, 20 cm, stainless

**SLine** 97384

06890.000

## Hook retractor forceps



### **Hook retractor forceps**

with 2 hooks and ratchet, take-apart, 20 cm, stainless

**SLine** 97381

07110.000



### **Pratt's hook retractor forceps**

with 4:4 teeth and ratchet, 26 cm, stainless

**SLine** 97380



### **Czerny's hook retractor forceps**

with 4:4 teeth and ratchet, 20 cm, stainless

**SLine** 97382

## Towel clips



### **Backhaus' towel clip**

13 cm, stainless

**SLine** 97070

07180.000



### **Backhaus' towel clip**

9 cm, stainless

**SLine** 97071

07182.000



### **Towel clip in forceps form**

9 cm, stainless

**SLine** 97072

07190.000

## Dressing forceps

### Gross' dressing forceps

stainless

Length

12,5 cm

 00002.360

14,0 cm

 97078.000

16,0 cm

 00002.370

20,5 cm

 00002.380



## Forceps

### Dissecting forceps

with serrated tips, stainless

Length

11,5 cm

 97010

07561.000

13,0 cm

 97011

07570.000

14,5 cm

 97012

07580.000

16,0 cm

 97013

07586.000

20,0 cm

 97014

07910.000

30,0 cm

 97015

07920.000

14,5 cm

 97016

07590.000

(extra fine)



### Tissue forceps

with 1:2 teeth, stainless

Length

11,5 cm

 97020

07700.000

13,0 cm

 97021

07710.000

14,5 cm

 97022

07720.000

16,0 cm

 97023

07756.000

14,5 cm

07751.000

(extra strong)



### Tissue forceps

with 2:3 teeth, stainless

Length

14,5 cm

07760.000

16,0 cm

07761.000



## **Forceps**

### **Splinter forceps**

stainless

Length

8,0 cm

**SLine** 97032

07850.000

10,0 cm

**SLine** 97030

11,5 cm

**SLine** 97033

07860.000

13,0 cm

**SLine** 97031

07861.000



### **Feilchenfeld's forceps**

11,5 cm, stainless

**SLine** 97035

07872.000

### **Troeltsch's dressing forceps for ear treatment**

12 cm, angular, stainless

**SLine** 97060

07971.000

### **Lucae's dressing forceps for ear treatment**

14 cm, bayonet, stainless

**SLine** 97050

07990.000

### **Iris forceps with serrated tips**

10 cm, straight, stainless

**SLine** 97040

30810.000

### **Iris forceps**

10 cm, half curved, stainless

**SLine** 97041

30830.000

### **Knapp's eyelid forceps**

for rolling out the eyelid, 11,5 cm, stainless

30881.000

### **Dental forceps with curved point**

serrated, 15 cm, stainless

**SLine** 97048

32085.000



## Scalpel handles

### Scalpel handle

metal, ca. 14 cm, stainless

08470.000



### Scalpel blades

individually steril packed, suitable for handle 08470.000

08480. ....



### Disposable scalpels with blade

made of plastic, individually steril packed, ca. 12 cm, box of 10 pieces (minimum quantity)

08510.220



### Bayha scalpel handle

metal, 13 cm, stainless

08490.000



### Bayha scalpel blades

individually steril packed, suitable for handle 08490.000, pack of 12 pieces

08500. ....

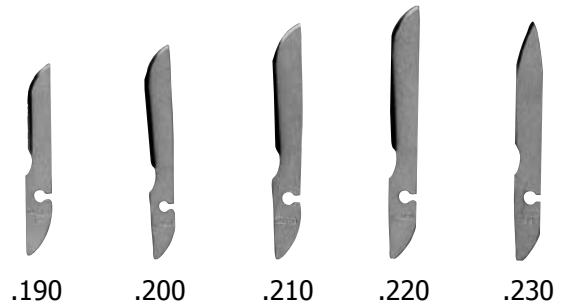

### Scalpel handle no. 3

stainless (for blades 97111-97112)

**SLine** 97103



### Scalpel blades

single, steril, minimum quantity 100 pieces of each size

**SLine** 97111-97112

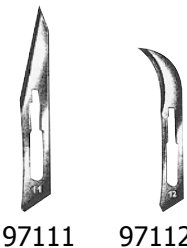

### Scalpel handle no. 4

stainless (for blades 97118-97124)

**SLine** 97104



### Scalpel blades

single, steril, minimum quantity 100 pieces of each size

**SLine** 97118-97124

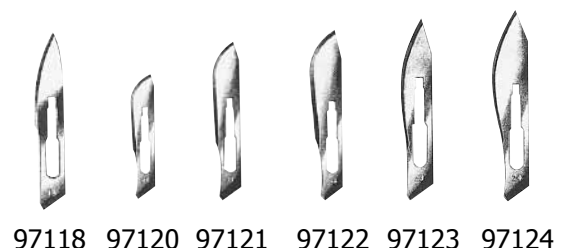

## Surgical scalpels



### **Surgical scalpel, rounded**

drop forged, hollow in the handle, 17,5 cm, stainless

08750.000



### **Surgical scalpel, straight probe ended**

drop forged, hollow in the handle, 17,5 cm, stainless

08930.000



### **Surgical scalpel, tenotome, probe ended**

drop forged, hollow in the handle, 17,5 cm, stainless

08950.000



### **Surgical scalpel, tenotome, pointed**

drop forged, hollow in the handle, 17,5 cm, stainless

08960.000

## Surgical scissors, stainless

### **Surgical scissors, straight, blunt-pointed**

Length



13,0 cm

**SLine** 97141

10702.000

14,5 cm

**SLine** 97142

10703.000

15,5 cm

**SLine** 97143

10705.000

16,0 cm

16,5 cm

**SLine** 97145

10707.000

18,0 cm

20,0 cm

10708.000

16,5 cm

(extra strong)

10801.000

### **Surgical scissors, straight, pointed-pointed**

Length



11,5 cm

**SLine** 97150

10712.000

13,0 cm

**SLine** 97151

14,5 cm

**SLine** 97152

10713.000

15,5 cm

16,0 cm

**SLine** 97153

10715.000

16,5 cm

18,0 cm

**SLine** 97156

10717.000

20,0 cm

10718.000

### **Surgical scissors, curved, blunt-blunt**

Length



13,0 cm

**SLine** 97161

14,5 cm

**SLine** 97162

16,5 cm

**SLine** 97163





## Surgical scissors, stainless

### Surgical scissors, curved, blunt-blunt

Length		
13,0 cm	 97190	10720.000
14,0 cm		10722.000
14,5 cm	 97192	
15,5 cm		10721.000
16,5 cm	 97193	10724.000
18,0 cm	 97195	10726.000
20,0 cm		10727.000
16,5 cm (extra strong)	 97199	10895.000



### Surgical scissors, curved, blunt-pointed

Length		
13,0 cm	 97171	10735.000
14,0 cm		10732.000
14,5 cm	 97172	
16,5 cm	 97173	10731.000
18,0 cm	 97175	10736.000
20,0 cm		10737.000





### Surgical scissors, curved, pointed-pointed

Length		
14,0 cm		10762.000
14,5 cm	 97182	
16,0 cm		10764.000
16,5 cm	 97172	





### Metzenbaum's scissors, straight, blunt-blunt

Length		
14,5 cm	 97231	10740.000
18,0 cm	 97232	10741.000
20,0 cm		10742.000
23,0 cm		10743.000
25,0 cm		10744.000
28,0 cm		10745.000
30,0 cm		10746.000



### Metzenbaum's scissors, curved, blunt-blunt

Length		
14,5 cm	 97241	10750.000
18,0 cm	 97242	10751.000
20,0 cm		10752.000
23,0 cm		10753.000
25,0 cm		10754.000
28,0 cm		10755.000
30,0 cm		10756.000



## Iris scissors



### **Iris scissors, straight**

Length  
10,5 cm  
11,5 cm

**SLine** 97261  
**SLine** 97263

30751.000



### **Iris scissors, curved**

Length  
10,5 cm  
11,5 cm

**SLine** 97262  
**SLine** 97264

30761.000



### **Iris scissors, lateral curved**

Length  
11,5 cm

**SLine** 97265

30771.000



### **Iris scissors, angled**

Length  
11,5 cm

**SLine** 97266

30781.000

## Scissors



### **Lister's dressing scissors, stainless**

Length  
14,0 cm  
18,0 cm

**SLine** 97251  
**SLine** 97253

11151.000



### **Richter's dressing scissors**

extra strong, blunt-blunt, 17,5 cm, stainless

**SLine** 97250

11152.000



### **Plaster shears**

20 cm, stainless

**SLine** 97257

11400.000



### **Foot ring scissors for birds**

10 cm, stainless

**SLine** 97200

11200.000



### **Spencer's ligature scissors**

straight, 9 cm, stainless

**SLine** 97210

11210.000



### **Scissors with one probe point**

straight, 14,5 cm, stainless

**SLine** 97211

49001.040



## Scissors with inserted carbide cutting edges

**blunt-pointed, straight, 14,5 cm**

**SLine** 97271 10901.000

**blunt-pointed, curved, 14,5 cm**

**SLine** 97272 10911.000

**pointed-pointed, straight, 14,5 cm**

**SLine** 97273 10902.000

**pointed-pointed, curved, 14,5 cm**

**SLine** 97274 10912.000

**blunt-blunt, straight, 14,5 cm**

**SLine** 97275 10903.000

**blunt-blunt, curved, 14,5 cm**

**SLine** 97276 10913.000

**Metzenbaum's scissors, blunt-blunt, straight**

Length

14,5 cm **SLine** 97281 10921.000

18,0 cm **SLine** 97283 10923.000

**Metzenbaum's scissors, blunt-blunt, curved**

Length

14,5 cm **SLine** 97282 10931.000

18,0 cm **SLine** 97284 10933.000

**Mayo's scissors, blunt-blunt, straight, 14,5 cm**

**SLine** 97285 10941.000

**Mayo's scissors, blunt-blunt, curved, 14,5 cm**

**SLine** 97286 10951.000



## Forceps

**Mosquito forceps with ratchet**

without teeth, stainless, straight

Length

10,0 cm 07211.000

12,5 cm **SLine** 97075 07210.000

**Mosquito forceps with ratchet**

without teeth, stainless, curved

Length

10,0 cm 07263.000

12,5 cm **SLine** 97076 07262.000

**Péan's artery forceps**

short jaws, stainless, straight

Length

14,5 cm **SLine** 97320 19131.000





## Péan's artery forceps

long jaws, stainless, straight

Length

13,0 cm

**SLine** 97304

19431.000

14,5 cm

**SLine** 97300

19441.000

16,0 cm

**SLine** 97301

19446.000

20,0 cm

**SLine** 97303

19451.000

## Péan's artery forceps

long jaws, stainless, curved

Length

13,0 cm

**SLine** 97314

19531.000

14,5 cm

**SLine** 97310

19536.000

16,0 cm

**SLine** 97311

19541.000

20,0 cm

**SLine** 97313

19551.000

24,0 cm

**SLine** 97315

19551.000



## Kocher-Ochsner's artery forceps

with 1:2 teeth, long jaws, stainless, straight

Length

14,0 cm

**SLine** 97350

19651.000

16,0 cm

**SLine** 97351

19652.000

20,0 cm

**SLine** 97353

19654.000



## Kocher-Ochsner's artery forceps

with 1:2 teeth, long jaws, stainless, curved

Length

14,0 cm

**SLine** 97371

19671.000

16,0 cm

**SLine** 97372

19672.000

20,0 cm

**SLine** 97374

19674.000

24,0 cm

**SLine** 97375

19674.000



## Doyen's intestinal forceps

diagonal serrated, elastic, 16,5 cm, stainless

straight

**SLine** 97412

39630.000

curved

**SLine** 97413

33220.000



## Doyen's intestinal forceps

longitudinal serrated, elastic, stainless

straight 24 cm

**SLine** 97401

39640.000

curved 23 cm

**SLine** 97411

33221.000



## Hartmann's intestinal forceps

diagonal serrated, 20 cm, stainless

straight

**SLine** 97414

39645.000

curved

**SLine** 97415

39646.000



## Allis' forceps for tissue grasping

with 5:6 teeth, 15 cm, stainless

**SLine** 97370

33100.000



## Dog ear clamps, light metal, 14 cm

straight

33053.000

curved

33063.000



## Bone instruments

### Liston's bone forceps

19 cm, stainless

 97611

20111.000

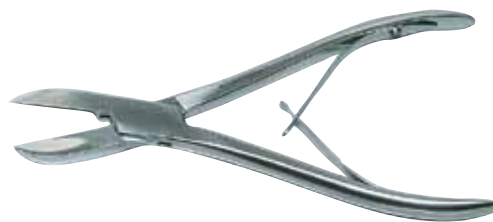

### Fergusson's bone holding forceps

21 cm, stainless

 97651

20151.000



## Sharp spoons

### Volkman-Collin's sharp spoon

spoon 15 x 10 mm, 20 cm long, stainless

 97600

11510.000



### Sharp spoon

spoon 10 x 7 mm, 15 cm long, stainless

11530.000



### Sharp spoon

spoon 2,3 mm Ø, 12 cm long, stainless

11560.000



### Volkman's double spoon, 15 cm long

spoon 20 x 6 mm Ø and 10 x 6 mm Ø, stainless

 97603

11640.000



### Volkman's double spoon, 20 cm long

spoon 22 x 7 mm Ø and 15 x 6 mm Ø, stainless

 97604

11660.000



## Retractors

### Retractor

with 4:4 blunt teeth, 10 cm, stainless

21800.000



### Retractor

with 4:4 sharp teeth, 10 cm, stainless

21801.000



### Weitlaner's retractor

with 3:4 sharp teeth, 13 cm, stainless

21802.000



### Weitlaner's retractor

with 3:4 sharp teeth, 16,5 cm, stainless

21803.000



## Electrosurgical unit

### Why use electrosurgery?

- ✓ Reduction of operating time by the omission of time-consuming ligatures and seams
- ✓ Less blood loss
- ✓ Optimized healing process and accelerated mobility of the patient
- ✓ Cost savings by less ligature-material usage



### **HBS 120 universal**

Electrosurgical unit for veterinary medicine

28100.000

Electrosurgery is a technique used for nearly all types of surgical procedures nowadays. Flowing through the tissue, high frequency current produces a thermal effect. This temperature rise and the evaporating of water from the tissue directly surrounding the electrode, creates the effect of haemostasis and cessation of bleeding (coagulation) or cutting (electrotomy).

The electrosurgical unit is a generator that transforms electrical energy into high frequency alternating current of the frequency above 300 kHz, which prevents the risk of accidental electrolysis or muscle and nerve stimulation.

The HBS 120 universal is a versatile electrosurgical unit which can be used for monopolar and bipolar operations. Not at least due to its microprocessor controlled electronic, the HBS 120 universal offers a high degree of safety.

With the maximum power of 120 watt the HBS 120 universal is in the upper level in the range of performance in its category and is applied preferably in veterinary and office-based practices.

The desired dosis can be exactly and comfortably adjusted. The chosen value is shown on the according display. The monopolar functions can be activated by a button on the handle or by using the foot switch. The bipolar output can be activated by the foot switch.

### Technical characteristics:

#### Monopolar Modes

Pure cut	120 W
Blend cut	80 W
Soft coagulation	80 W
Forced coagulation	80 W

#### Bipolarer Mode

Bipolar coagulation	80 W
---------------------	------

#### Power supply

Power supply voltage	230 V +- 10 % 50 Hz
Nominal power consumption	200 W

#### Other

Operating frequency	357 kHz
Dimensions (LWH)	340 x 240 x 100 mm
Weight	6,5 kg

#### Safety Conditions

Electric shock protection	Class I
	Type: CF
Low-frequency leakage	according to IEC 60601-1
High-frequency leakage	according to IEC 60601-2-2

### Monopolar Operation

In the monopolar mode, high frequency current is applied to the issue by an active electrode. The effect of section or coagulation is possible due to a high density of HF current on the small surface of the active electrode. The HF current flows through the patient's body to a neutral electrode and is dispersed on its surface. This enables lowering the density of HF current, and there is no undesired thermal effect where the neutral electrode is applied. Through the neutral electrode, the current flows back to the generator.

## Bipolar Operation

During bipolar operation, HF current flows between the two sides of a bipolar instrument and is only concentrated on the tissue between them. Bipolar work carries no danger of current flowing through the patient's body. The risk of burns in the areas distant to the operation is minimized. There is no need to use the neutral electrode for bipolar operations.

## Accessories

Electrode handle without push-buttons for electrodes 4 mm, connection cable 4 m and plug 28102.010



Connecting cable for bipolar forceps  
3 m 28101.010  
5 m 28101.020



NEW:  
Bipolar forceps with exchangeable tips



Electrode handle with pushbuttons for electrodes 4 mm, connection cable 4 m and plug 28102.020



**Length 160 mm:**

**straight:**  
Needle  
28101.100 0,5 mm  
28101.110 1,0 mm  
28101.120 2,0 mm  
28101.130

**curved:**  
Needle  
28101.200 0,5 mm  
28101.210 1,0 mm  
28101.220 2,0 mm  
28101.230

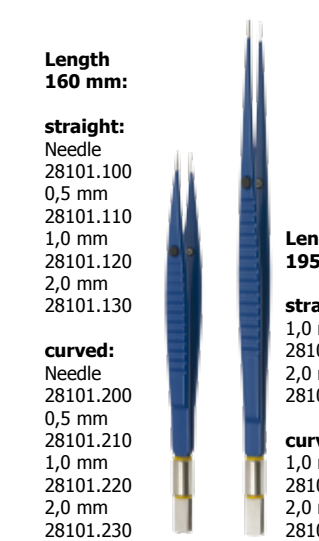

**Length 195 mm:**

**straight:**  
1,0 mm 28101.170  
2,0 mm 28101.180

**curved:**  
1,0 mm 28101.270  
2,0 mm 28101.280



Needle-electrode, Ø 0,7 mm 28102.600

Knife-electrode, oval shape, 25 x 3,0 mm 28102.100

Spatula-electrode, oval shape, 25 x 3,0 mm 28102.200

Lancet cutting electrode, straight, thin, 20 x 1,8 mm 28102.300

Lancet cutting electrode, straight, 25 x 2,2 mm 28102.310

Wire loop, Ø 5 mm 28102.400

Wire loop, Ø 10 mm 28102.410

Ball electrode, Ø 2 mm 28102.500

Ball electrode, Ø 4 mm 28102.510

Ball electrode, Ø 6 mm 28102.520

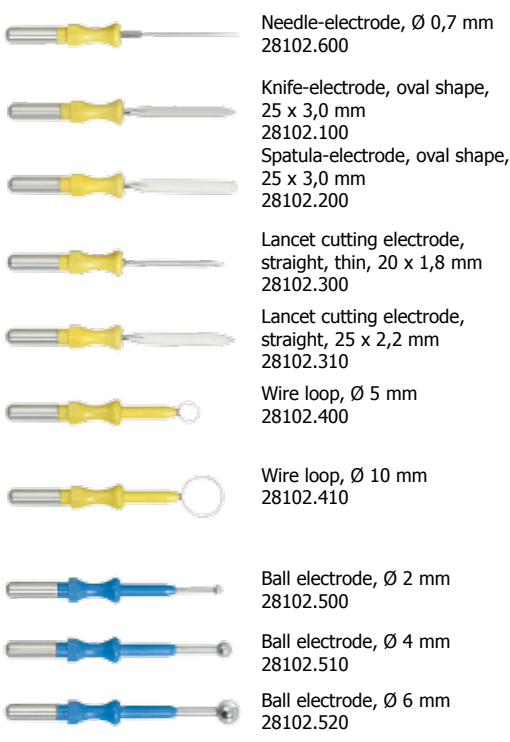

**Length 165 mm:**

Needle  
28101.300 0,5 mm  
28101.310 1,0 mm  
28101.320

**Length 195 mm:**

1,0 mm 28101.370  
2,0 mm 28101.380

curved design

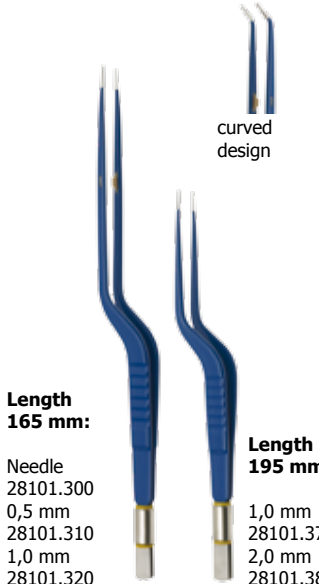

Nadel 0,5 mm 1 mm 2 mm

**Tips straight:**

Needle 28103.100 0,5 mm 28103.110 1,0 mm 28103.120 2,0 mm

**Tips curved:**

Needle 28103.200 0,5 mm 28103.210 1,0 mm 28103.220 2,0 mm

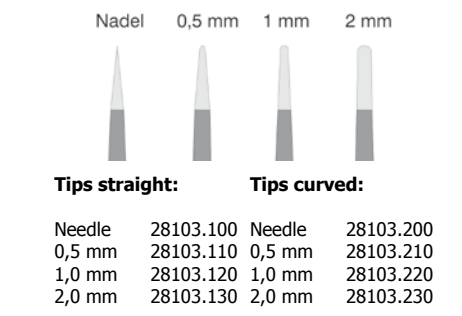

Extension for electrodes with 4 mm shaft, 125 mm 28102.820

Rubber band with fixing button  
50 cm 28100.600  
100 cm 28100.610

Rubber neutral electrode cable length 4 m  
8 x 16 cm 28100.500  
26 x 16 cm 28100.510

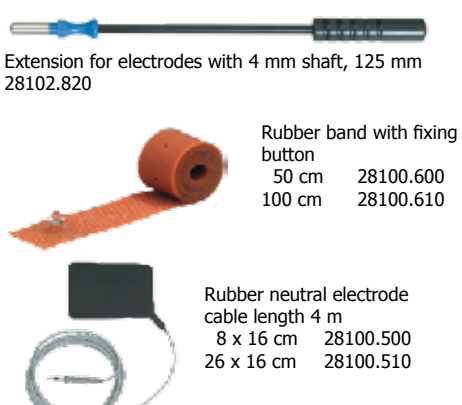

Double foot switch, cable length 5 m 28100.100



Special tool for safe change of tips 28103.800

Special forceps to remove tips 28103.810



Electrode container with 10 standard electrodes 28102.800  
Electrode container without electrodes 28102.810



This is a small selection from our large assortment of accessories, if there are any further wishes, please feel free to contact us!

## Suture needles

### **Set suture needles (19 pcs.)** ▼

☐ curved, stainless steel, cutting because of triangular shape, spring head, in heat sealed visible packing (Dimensions are in the table)

20700.000

### **Suture needles** ▼

in denoted size, pack of 12 pieces (Dimensions are in the table)

20700. ....

### **Set suture needles (19 pcs.)** ●

☐ curved, stainless steel, round shape, spring head, in heat sealed visible packing (Dimensions are in the table)

20705.000

### **Suture needles** ●

in denoted size, pack of 12 pieces (Dimensions are in the table)

20705. ....

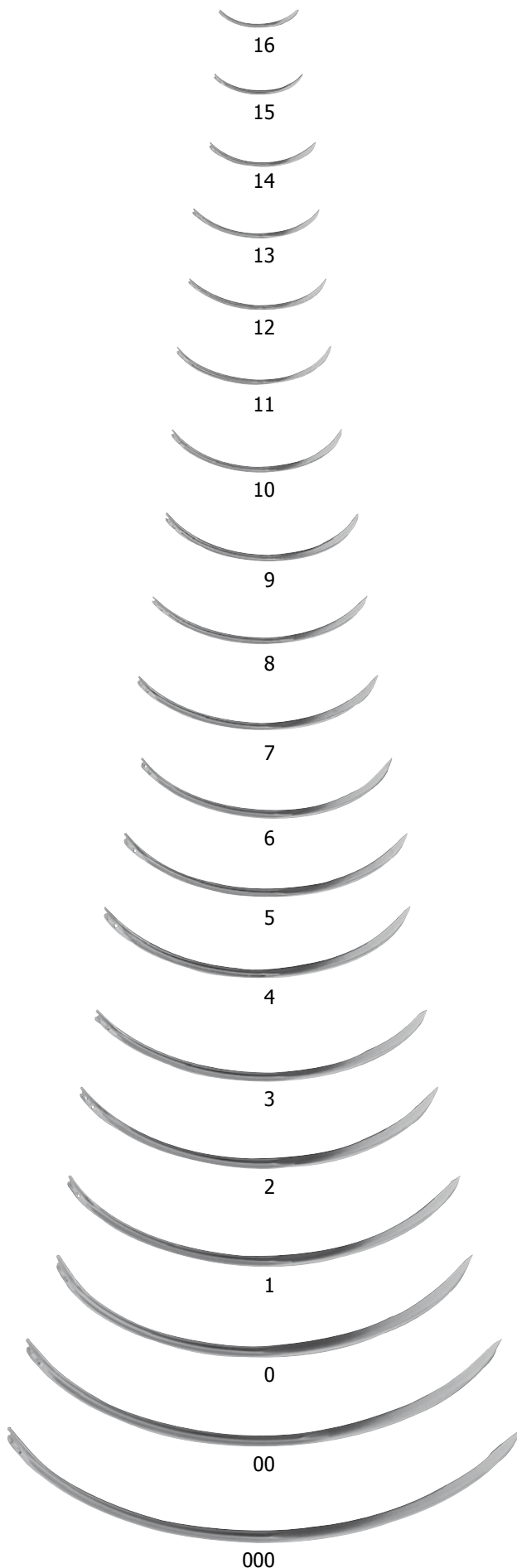

Size:	Dimensions:	▼ Art.-no.: ●
16	0,6 x 18 mm	20700.160 / 20705.160
15	0,6 x 20 mm	20700.150 / 20705.150
14	0,7 x 22 mm	20700.140 / 20705.140
13	0,8 x 28 mm	20700.130 / 20705.130
12	0,8 x 30 mm	20700.120 / 20705.120
11	0,8 x 34 mm	20700.110 / 20705.110
10	0,9 x 36 mm	20700.100 / 20705.100
9	1,0 x 40 mm	20700.090 / 20705.090
8	1,0 x 45 mm	20700.080 / 20705.080
7	1,1 x 50 mm	20700.070 / 20705.070
6	1,1 x 55 mm	20700.060 / 20705.060
5	1,2 x 60 mm	20700.050 / 20705.050
4	1,3 x 65 mm	20700.040 / 20705.040
3	1,3 x 70 mm	20700.030 / 20705.030
2	1,4 x 75 mm	20700.020 / 20705.020
1	1,4 x 80 mm	20700.010 / 20705.010
0	1,6 x 85 mm	20700.220 / 20705.220
00	1,6 x 92 mm	20700.210 / 20705.210
000	1,8 x 100 mm	20700.200 / 20705.200

## Suture needles

### Set suture needles (19 pcs.) ▼

½ curved, stainless steel, cutting because of triangular shape, spring head, in heat sealed visible packing (Dimensions are in the table)

20710.000

### Suture needles ▼

in denoted size, pack of 12 pieces (Dimensions are in the table)

20710. ....

### Set suture needles (19 pcs.) ●

½ curved, stainless steel, round shape, spring head, in heat sealed visible packing (Dimensions are in the table)

20715.000

### Suture needles ●

in denoted size, pack of 12 pieces (Dimensions are in the table)

20715. ....

Size:	Dimensions:	▼ Art.-no.: ●
16	0,6 x 18 mm	20710.160 / 20715.160
15	0,6 x 20 mm	20710.150 / 20715.150
14	0,7 x 22 mm	20710.140 / 20715.140
13	0,8 x 28 mm	20710.130 / 20715.130
12	0,8 x 30 mm	20710.120 / 20715.120
11	0,8 x 34 mm	20710.110 / 20715.110
10	0,9 x 36 mm	20710.100 / 20715.100
9	1,0 x 40 mm	20710.090 / 20715.090
8	1,0 x 45 mm	20710.080 / 20715.080
7	1,1 x 50 mm	20710.070 / 20715.070
6	1,1 x 55 mm	20710.060 / 20715.060
5	1,2 x 60 mm	20710.050 / 20715.050
4	1,3 x 65 mm	20710.040 / 20715.040
3	1,3 x 70 mm	20710.030 / 20715.030
2	1,4 x 75 mm	20710.020 / 20715.020
1	1,4 x 80 mm	20710.010 / 20715.010
0	1,6 x 85 mm	20710.220 / 20715.220
00	1,6 x 92 mm	20710.210 / 20715.210
000	1,8 x 100 mm	20710.200 / 20715.200

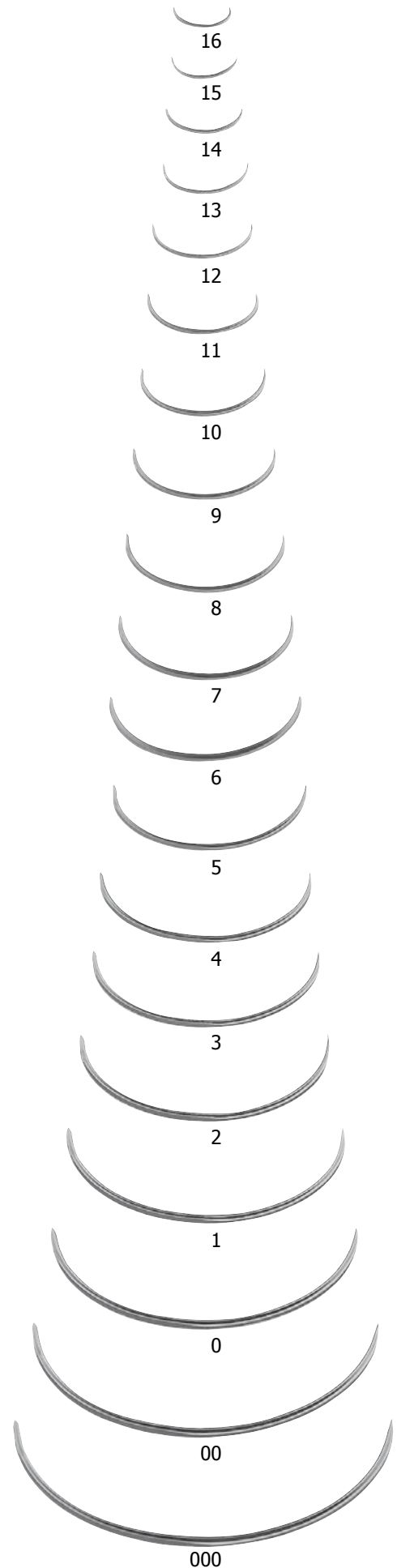

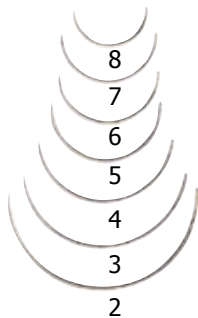
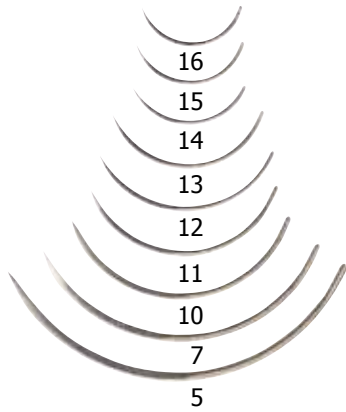

## Suture needles

### **Suture needles**

triangular shape, curved, small design, spring head, stainless, all needles are available in packs of 12 pcs. each size in heat sealed visible packing

- Not available in sets -



20690. ...

### **Suture needle for intestinal**

round shape, curved, spring head, stainless, all needles are available in packs of 12 pcs. each size in heat sealed visible packing

- Not available in sets -



20691. ...

### **Needle for foreign body operations**

round shape, totally curved, spring head, stainless  
Size 5



39600.000

### **Needle for foreign body operations**

triangular shape, totally curved, spring head, stainless  
Size 7



39620.000

### **Eye needle**

round shape, totally curved, spring head, stainless



30730.000

### **Needle for abomasum operation**

round, triangular shape, stainless, 13,5 cm wide



21130.000

### **Sterilising and storage container for suture needles**

with sliding lid, 65 x 42 x 8 mm, stainless

22983.000

### **Gerlach's suture needle**

15 cm, chrome-plated

21150.000

### **Hauptner's suture needle**

for the surgical suturing method in vaginal and uterine prolapsus, 24 cm, chrome-plated

43400.000



## Suture material

### Suture material for the veterinary practice

This suture material is made from high quality raw material in high cleanness coming out from an optimal manufacturing process:

- ✓ sterile
- ✓ absorbent, proven thread
- ✓ precise diameter of thread
- ✓ good suppleness

### Catgut plain, cassette

Ø EP metric	Ø USP old	meter	
2	4/0	100	20520.020
3	3/0	100	20520.030
4	0	75	20520.040
5	1	75	20520.050
6	2	50	20520.060
7	3	40	20520.070
8	4	25	20520.080
9	5	25	20520.090
10	6	25	20520.100



### Catgut plain

Catgut plain is made of a high quality raw material in an optimised manufacturing process which results in a thread of extremely pure collagen. This suture has top mechanical properties and precise diameter. Its absorption time is perfectly fitted to the needs in veterinary application. Catgut plain is preserved in a special soaking solution which contributes and preserves the ductility of this soft material.

**Please visit our website**

**[www.hauptner-herberholz.de](http://www.hauptner-herberholz.de)**



## Catgut chrom, cassette

Ø EP metric	Ø USP old	meter	
2	4/0	100	20510.020
3	3/0	100	20510.030
4	0	75	20510.040
5	1	75	20510.050
6	2	50	20510.060
7	3	40	20510.070
8	4	25	20510.080
9	5	25	20510.090
10	6	25	20510.100

## Catgut chrom

Catgut chrom has approximately double the absorption time compared to Catgut plain and is therefore recommended mainly for the suture of the fascia.



## Supramid extra, black

- ✓ steril
- ✓ non-absorbent
- ✓ polyamid-coated ployamid fibres
- ✓ proven, completely smooth surface
- ✓ safety, optimal positioning of the knot

## Supramid extra, black, cassette

Ø EP metric	Ø USP old	meter	
2	3/0	100	20530.020
3	2/0	100	20530.030
4	1	75	20530.040
5	2	75	20530.050
6	3+4	50	20530.060
7	5	40	20530.070
8	6	40	20530.080

## Supramid

With the sizes USP 4/0 and thicker Supramid consists of a multifilament core of polyamide, coated by a tube made out of the same material. As a result, the suture gains three valuable properties: a high tensile strength, a good knot placement and a smooth surface. Preferential use is for skin closure.

## Needle holder

### **Mathieu's needle holder**

stainless

Length

14,0 cm

 97500

21623.000

17,0 cm

 97501

21621.000

20,0 cm

 97502

21622.000

### **Mathieu's needle holder**

stainless, with carbide inserts

Length

14,0 cm

 97525

21625.000

17,0 cm

 97526

21626.000

20,0 cm

 97527

21627.000

### **strong model for large animals, 20 cm**

 97531

21631.000

### **Olsen-Hegar's needle holder**

stainless, with scissors and carbide inserts

Length

14,0 cm

 97528

21628.000

16,0 cm

 97529

21629.000

18,0 cm

 97530

21630.000

### **Mayo-Hegar's needle holder**

stainless, with carbide inserts

Length

16,0 cm

 97541

21641.000

18,0 cm

 97542

21642.000

20,0 cm

 97543

21643.000

### **strong model for large animals**

Length

20,0 cm

 97545

21645.000

24,0 cm

 97546

21646.000

### **Crile-Wood model of needle holder**

15 m, stainless, with carbide inserts

 97532

21632.000

### **Halsey model of needle holder**

13 cm, stainless, with carbide inserts

 97536

21636.000

### **Ermold's needle holder**

17 cm, stainless

 97549

21773.000

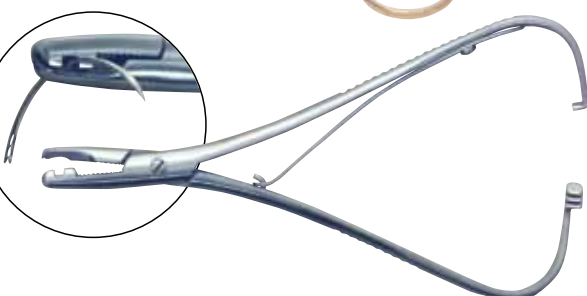

## Wound clips

### Wound clips

stainless, package of 100 pieces



7,5 mm	22108.000
12 mm	22110.000
14 mm	22111.000
16 mm	22112.000
18 mm	22113.000

### Michel's forceps for applying wound clips

12 cm, stainless

22101.000



### Forceps for applying and removing wound clips (No. 22110.000 - 22113.000)

12 cm, stainless

22102.000

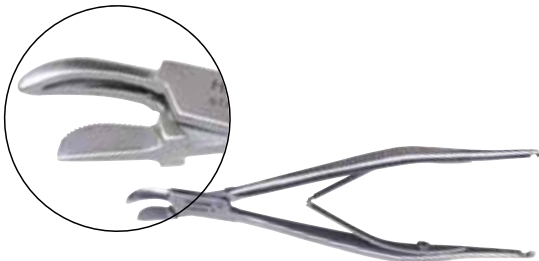

### Large wound clip for cattle

nickel-plated, ca. 2,4 x 33 mm, Pack of 100 pieces

22120.000



### Forceps for clips (Nr. 22120.000)

15 cm, stainless

22125.000

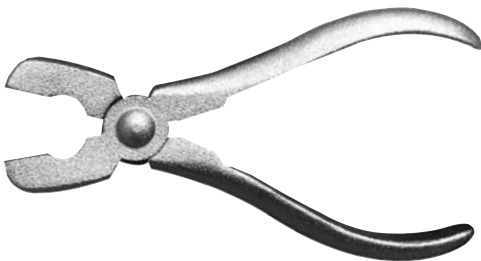

### Wound suture with large clips for cows

This method with our large wound clips is a method for suturing by clips. It can be used for example after caesarean section of cows for suturing the outer skin. The large clips are applied after holding the edges of the wound together by fixing them with forceps and setting the clips in distances of about 10 mm. The wound clips 22120 are applied with forceps 22125.

After the healing it is easy to cut off the clips with any cutting forceps and pull out the two parts carefully.

## Cautery and burners

### **Electric cautery**

80 watt / 230 volt, with integrated lighting, 1 short burner

28161.000

28160.000



### **Adaptor-set**

for the use of older burners

28160.010

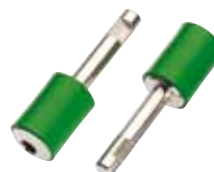

## Burners made of special metal

### **Knife shaped burner**

28121.000



### **Ball shaped burner**

28122.000



### **Loop shaped burner**

28123.000



### **Knife shaped burner, pointed**

28124.000



### **Pointed burner**

28125.000



## Burners made of normal metal

### **Short burner**

28161.000



### **Long burner**

28162.000



### **Knife shaped burner**

28163.000



### **Wide and curved burner**

(for dabbing)

28164.000



## Post mortem instruments

### Post mortem set

in solid aluminium case

49510.000

**All instruments are separately available!**



contains the following instruments:

<b>Bow saw</b>	49361.000	<b>Dissecting knife, 21 cm</b>	60401.210
<b>Saw</b>	49350.000	<b>Bowel scissors</b>	49060.000
<b>Hammer</b> tempered steel, nickel-chrome plated	49181.000	<b>Tenotomy scissors</b>	49070.000
<b>Spine wrench</b>	49220.000	<b>Dissecting forceps</b>	07580.000
<b>Chisel, 20 cm</b>	49200.000	<b>Bone holding forceps</b>	20151.000
<b>Chisel, 23 cm</b>	49210.000	<b>Bone scissors</b>	20111.000
<b>Dissecting knife, 13 cm</b>	60402.130	<b>Probe, 2 mm Ø</b>	06352.000
<b>Cartilage knife</b>	49011.000	<b>Probe, 3 mm Ø</b>	06351.000
		<b>Measure</b>	49550.000

### Post mortem

For large animals horses, cows, calves, pigs and sheep, it could be necessary to find out the exact cause of death because of different reasons like dangerous diseases and others. By using our high quality instruments we can guarantee accurate and efficient post mortem. For the dissection of small animals like dogs, cats, rabbits, etc. usually the surgical instruments can be used, which are standard equipment in every veterinary clinic.

## Meat inspection

### **Meat inspection knife, rounded**

with white plastic handles, sterilisable, blade length 17 cm, length 31 cm

60050.000



### **Meat inspection knife, pointed**

with white plastic handles, sterilisable, blade length 17 cm, length 31 cm

60051.000



### **Sheath of plastic**

for 2 meat inspection knives, with protection of legs

60325.000



### **Sheath of plastic**

for 1 meat inspection knife, with holder

60324.000

### **Sheath of plastic for 2-3 knives**

60326.000

### **Sheath of plastic for 3-4 knives**

60328.000

### **Marking scissors with curved points**

straight shanks, 19 cm, stainless

72321.000



### **Trichino scissors, stainless**

11 cm, straight  97220

51371.000

11 cm, curved  97221

51411.000

13 cm, curved  97222

51430.000



## Butcher-knives

Butcher-knife, made of molybdenum-chrome-vanadium-steel, with safety plastic handle

### **Butcher-knife**

blade length 16 cm

60400.160

blade length 18 cm

60400.180



### **Skinning knife**

blade length 21 cm

60401.210



### **Sticking knife**

blade length 13 cm

60402.130

blade length 16 cm

60402.160



### **Pro-butcher knife**

blade length 18 cm

60403.180

blade length 21 cm

60403.210



### **Pro-butcher knife**

blade length 25 cm

60403.250

blade length 30 cm

60403.300



## For easy sharpening of knives and blades



### **Sharpening steel with wooden handle**

17 cm long, hard-chrome-plated

49040.000



### **Sharpening steel with plastic handle**

35 cm long, hard-chrome-plated

49050.000



## Microscope and Meat inspection

### **Trichino-microscope**

in wooden box, with convexe and plan mirror, iris-diaphragm, stage ca. 80 x 210 mm

2 fold revolving nosepiece

achrom-objectives: 4x and 10x

widefield ocular: 10x in 30 mm adapter

50130.000



### **Lamp, fits to microscope 50130**

(for production series from 7.99), exchangeable for the mirrors, with cobalt blue filter, 220 V / 15 W

50121.000



### **Compressor for meat inspection**

glass, 28 divisions, 23 cm long, 5 cm wide

52500.000



### **Plastic container**

for 15 meat samples, with numbered sections

60640.000

**Please visit our website**

**[www.hauptner-herberholz.de](http://www.hauptner-herberholz.de)**



## Microscope and Meat inspection

### **Binocular routine Microscope MC 50**

magnifying up to 1000 x

- Modern economic metal basis, binocular tubes 30
- 360° rotatable with dioptic adjustment
- 4 fold revolving nosepiece mounted on ball bearing
- coaxial coarse and fine adjustment
- DIN achromat objective 4/0.10, 10/0.25, 40/0.65 and 100/1.25 oilim
- 1 pair widefield oculares WF 10x/18
- Abbe condensor n.A. 1.25, with irisdiaphragm, adjustable in height
- filter holder, with blue filter
- mechanical stage
- built-in Halogene illumination 220 V / 15 W variable illuminated
- delivered with operating instructions, sleeve, immersion oil and spare lamp in a styrofoam box

50136.000



### **Stereo-microscope**

- Magnifying 20x and 40x, switchable by objective revolver
- Stereohead with 2 objectives 2x and 4x and widefield oculare 10x
- stativ with threefold examination (incident light, transmitted light and mixed light)
- Incident light: 20 W halogen-lamp
- Transmitted light: 10 W halogen-lamp (approx. 10.000 hours)

50134.000



### **Microscopes**

With the above mentioned microscopes you will create an important base for optimised examinations. The objectives give a realistic picture of the examining probe without coloured edges, because of the achromatic lenses of high quality in the composition of the objectives. The picture is enlarged, but as reversed-picture, good visibility. The augmentation is dependant on the combination of the objectives and oculars with their focus. For example a 10x objective combined with a 10x ocular results in a 100x augmentation. A clear picture of the examined object is achieved by turning the fine-focus.

## Meat inspection stamps

Stamp's surface made of rubber or brass

### with reversible handle



Description	Plastic	Brass
<b>1)</b> consumption suitable meat - from the slaughterhouse -	60721.000	60761.000
<b>2)</b> disqualified meat	60723.000	60763.000
<b>3)</b> consumption suitable meat - slayed big wild game - after meat inspection	60724.000	60764.000
<b>4)</b> consumption suitable meat - slayed big wild game - free of trichinae	60726.000	60766.000

### with plastic handle (10 cm)



### with hammer handle 50 cm



Description	Plastic	Brass	Brass
<b>1)</b> consumption suitable meat - from the slaughterhouse -	60701.000	60741.000	60781.000
<b>2)</b> disqualified meat	60703.000	60743.000	60783.000
<b>3)</b> consumption suitable meat - slayed big wild game - after meat inspection	60704.000	60744.000	60784.000
<b>4)</b> consumption suitable meat - slayed big wild game - free of trichinae	60706.000	60746.000	60786.000
<b>5)</b> consumption suitable meat - hoofed and domestic animals - emergency slaughter outside the slaughterhouse	60708.000	60748.000	---
<b>6)</b> disqualified meat of hoofed game	60709.000	60749.000	---
<b>7)</b> DE EG - Stamp	60719.000	60759.000	60789.000

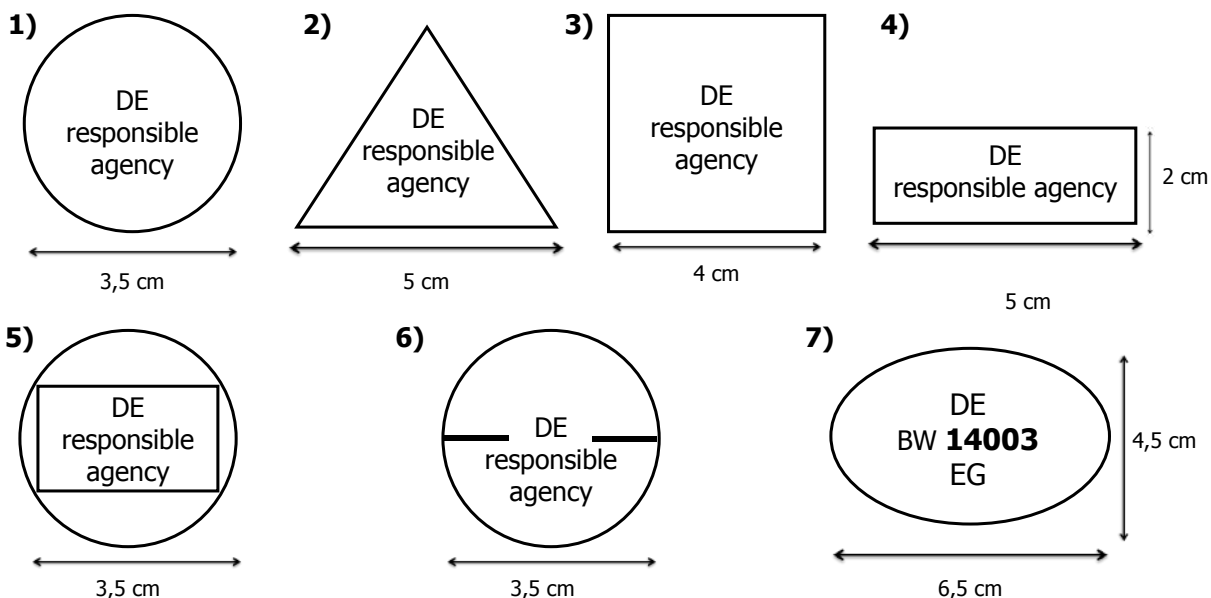

## Meat stamping ink and accessories

### Meat stamp dye, non-toxic, according to EG-laws

#### Brilliant blue E 133

250 ml	61660.250
1 l	61661.000
5 l	61662.000

#### Brown E 155

250 ml	61680.250
1 l	61681.000
5 l	61682.000

#### Red E 129

250 ml	61670.250
1 l	61671.000
5 l	61672.000



### Meat stamp dye for the dyeing of meat at risk

blue, 1 l for risk meat	61665.000
blue, 5 l for risk meat	61666.000
blue, 25 l for risk meat	61666.500
red, 1 l for risk meat	61668.000
red, 5 l for risk meat	61669.000
red, 25 l for risk meat	61669.500



### Spraying head

for 1-liter-bottles

61665.150



### Ink-pad

61550.000

### Stapler with long needles

for fixing threads and tags

53000.000

### Plastic tags for marking pieces of meat

non-toxic, food approval, made of red or white 0,2 mm foil strong, if desired with black numbers/letters

white / 100 pieces	53101.000
red / 100 pieces	53106.000

### Thread

40 mm long, with food approval, yellow, pack of 100 pieces

53202.400



## Meat inspection equipment

Meat inspection by artificial digestion method to discover trichines

### **Magnet stirrer**

complete with heating 135 mm Ø, stirring rod of PTEE, magnet 40 mm long, stand rod V2A, thermometer holder and digital thermometer 0-150°C, cable ca. 65 cm long and socket

50202.000

### **Stirring rod remover**

50203.000

### **Large glass**

3 liter

50211.000

### **Glass separating funnel**

with glass plug valve, 2000 ml

50206.000

### **Glass plug valve**

7 cm, Ø from 24 mm to 17 mm

50206.010

### **Glisseal N**

grease for laboratories, for lubrication and sealing of stop-cocks, suitable for vacuum -40°C bis +300°C, 60 g

50206.020

### **Plate stand**

with ring and double socket

50207.000

### **Glass funnel**

15 cm Ø

50208.000

### **Pipette**

with ball, 30 ml

50209.000

### **Centrifuge tube**

50 ml, graduated

50204.000

### **Metallic sieve**

according to DIN 4188, 18 mm opening, 100 mm Ø

50212.000

### **Bowl**

with net-work 1 x 1 cm, border height 2 cm, 9 cm Ø

50163.000

### **Chemical thermometer**

20,5 cm long, 0,7 cm Ø

50213.000

### **Safety-pipette, 10 ml**

50214.000

### **Magnet, 55 mm (triangular)**

50201.020



## „MUTO“<sup>®</sup>-Syringes

- ✓ easy handling because of ergonomic shape
- ✓ absolute exact dosification
- ✓ the adjusted dosage is going to be injected until the syringe is completely empty
- ✓ all parts are interchangeable
- ✓ with screw-on mount or Luer-Lock mount
- ✓ made of high-quality raw material



### „MUTO“<sup>®</sup>-syringe, Luer-Lock-mount

	adjustable dosages in ml	
10 ml	0,25 - 0,5 - 0,75 - 1	16302.000
25 ml	0,5 - 1 - 1,5 - 2 - 2,5	16356.000
30 ml	1 - 2 - 3 - 4 - 5	16362.000
50 ml	1 - 2 - 3 - 4 - 5	16392.000



### „MUTO“<sup>®</sup>-syringe, screw-on mount

	adjustable dosages in ml	
10 ml	0,25 - 0,5 - 0,75 - 1	16300.000
25 ml	0,5 - 1 - 1,5 - 2 - 2,5	16355.000
30 ml	1 - 2 - 3 - 4 - 5	16360.000
50 ml	1 - 2 - 3 - 4 - 5	16390.000



### Cleaning

After finishing the vaccination and emptying the Muto syringe the cleaning of all parts is important. Rinse the syringe after the vaccination several times with hand-warm water, this means suck-in and inject out. The syringes are able to be boiled-out.

One of the most important points to be considered is the emptying of the vaccine rests, which are not used during the vaccination, because some medicaments could react aggressively to the inside rubber plunger and the rubber washers.

















During time the rubber plungers can swell, especially after non-sufficient cleaning. In this case the use of the syringe can be harder and you would need more power to press the trigger. At this moment it is recommended to replace not only the rubber plunger, but all the other washers as well.

All spare parts for example washer sets, glass barrels, ratchet with spring and screw, plunger rod (complete or single) are available individually and can be replaced easily by the owner.

### The well proved injection-system

The flexible injection extension of Hauptner-Herberholz in combination with the MUTO-syringe enables an easy one-hand injection of animals. With your free hand it is now possible to mark the vaccinated animal. Due to the good quality material used it is possible to compensate the movement of the animal and to reduce breakage of needles considerably. (Injection extensions see page 42)

## Spare parts for „MUTO“<sup>®</sup>-syringes

	Description	16300.000	16355.000	16360.000	16390.000
		16302.000	16356.000	16362.000	16392.000
		10 ml	25 ml	30 ml	50 ml
	Complete grip, nickel-chrome-plated	16300.660	16355.660	16360.660	16360.660
	Large grip shank, including complete dosage sleeve, nickel-chrome-plated	16300.670	16355.670	16360.670	16360.670
	Small grip shank, including ratchet set, nickel-chrome-plated	16360.680	16360.680	16360.680	16360.680
	Ratchet set with accessories	16300.760	16300.760	16300.760	16300.760
	Complete dosage sleeve, nickel-chrome-plated	16300.560	16355.560	16360.560	16360.560
	Complete plunger rod, nickel-chrome-plated	16300.700	16355.700	16360.700	16390.700
	Inner plunger rod, nickel-chrome-plated	16300.430	16355.430	16360.430	16390.430
	Outer plunger rod, nickel-chrome-plated - When changing put the short, smooth part ahead -	16300.120	16390.120	16360.120	16390.120
	Needle mount with thread mount and washer, nickel-plated	16300.200	16355.200	16360.200	16360.200
	Needle mount with Luer-Lock mount, nickel-plated	16300.200+ 16517.000	16356.200	16362.200	16362.200
	Metal cover, aluminium anodised	16300.080	16355.080	16360.080	16390.080
	Glass barrel	14610.010	16355.690	14650.010	16390.090
	Set of plunger and washers	14610.500	16355.500	14650.500	14650.500
	Locking screw, nickel-chrome-plated	16360.370	16360.370	16360.370	16360.370
	Spring, nickel-chrome-plated	16360.330	16360.330	16360.330	16360.330
	Tension screw, nickel-chrome-plated	16300.210	16360.210	16360.210	16360.210

## „MUTO“<sup>®</sup>-Express II syringes

- ✓ for mass injections, up to 800 injections in one hour
- ✓ adjustable dosages: 0,5, 1,2,3,4, und 5 ml
- ✓ absolute exact dosages
- ✓ the adjusted dosage is going to be injected until the syringe is completely empty
- ✓ all parts are interchangeable
- ✓ with screw-on mount or Luer-Lock mount
- ✓ made of high-quality raw material



### **„MUTO“<sup>®</sup>-Express II syringe**

with thread mount

17000.000

### **„MUTO“<sup>®</sup>-Express II syringe**

with Luer-Lock mount

17002.000

### **„MUTO“<sup>®</sup>-Express II syringe with bottle holder**

- For vaccine bottles of 21 mm neck diameter, other dimensions on request
- Automatic injection out of the bottle via bottle holder or with clear tubing directly out of other vaccine bottle

with thread-mount

17010.000

with Luer-Lock mount

17012.000

### **Bottle-holder single**

for bottles with 21 mm neck diameter

17010.210

### **Bottle-holder single**

for bottles with 31 mm neck diameter

17010.310

### **Spare parts:**

#### **Ratchet set with accessories**

16300.760

#### **Glass barrel**

17000.160

#### **Set of plunger and washers**

17000.500

#### **Set of 2 valve balls and 2 springs**

stainless

17000.560

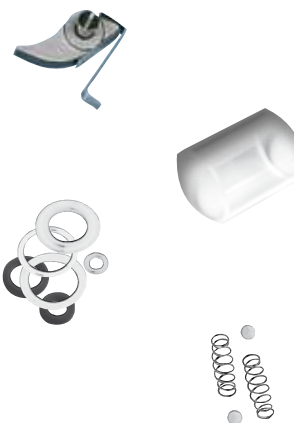

## Injection extensions for „MUTO“®- and „MUTO“®-Express II syringes



**Flexible injection extension („MUTO“®-syringe)**  
with screw-on mount, 25 cm long, made of strong plastic material - recommended for injection of pigs -

16361.000

**Flexible injection extension („MUTO“®-syringe)**  
made of plastic, with screw-on mount, 35 cm long

16361.950

with screw-on mount, 50 cm long

16361.970

Special length on demand

16361.980

**Rigid injection extension for „MUTO“®-syringe**

50 cm, inclusive assembly, aluminium anodised (not usable for 16355)

16371.000

**Injection extension for „MUTO“®-syringe**

1,0 m inclusive assembly (not usable for 16355), aluminium anodised

16372.000

This rigid extension is installed between the grip and pistons of the syringe and relieved the injection from larger distance. The lightweight syringe enables an easy one-hand injection. The sturdy material enables reduced wear and easy cleaning.



**Flexible injection extension for „MUTO“®-Express II and „MUTO“®-syringe (after removing the adapter ring)**

made of plastic, length 35 cm

- especially recommended for mass injections -

17035.000

**Tubing set**

with Luer-Lock mount and plastic tubing, 12 cm

16550.000

with screw-on mount and plastic tubing, 12 cm

16500.000

## Injection sticks, the ideal addition for all types of „MUTO“®-syringes

one-piece, made of flexible plastic with tubing

**Injection stick, 70 cm**

screw-on mount

16373.000

Luer-Lock mount

16373.500

**Injection stick, 90 cm**

screw-on mount

16374.000

Luer-Lock mount

16374.500



## **Sterimatic**

Automatic needle sanitizing system for attaching to all our „MUTO®-syringes with thread mount. Each cap will give you 100 automatic disinfections and will last for 3 days after opening.

### **Sterimatic Set**

16366.000

Set consisting of:

### **Disinfection cap (5 pieces)**

33871.200

### **Sterimatic sleeve, green**

16367.020

With the green sleeve and 35 mm long needles you can do intramusculaire injection (22 mm deep) for example against Blue tongue disease in cattle.



Recommended Luer-Lock-needles, reusable  
(not included in the set)

### **Luer-Lock-needle 1,8 x 35 mm**

injection depth 22 mm, stainless

17053.050

### **Luer-Lock-needle 1,6 x 25 mm**

injection depth 12 mm, stainless

17053.430



### **Mono-Bloc Luer Lock**

nickel-plated

15980.250



### **Adapter for the sleeve**

nickel-plated

16366.100



We can also deliver extra slim Luer-Lock-needles that gives you an injection depth of 25 mm (by 35 mm needle length) or alternatively 15 mm (by 25 mm needle length).

## Tuberculin-syringe and accessories



### **„MUTO“®-Tuberkulina 50 S**

with plexi-barrel and metal plunger, needle mount  
16102.250, 5 ml capacity, adjustable dosages 0,1 ml - 0,2 ml - 0,3 ml and 0,4 ml

33870.000

### **„MUTO“®-Tuberkulina 50 S**

with plexi-barrel and metal plunger, needle mount  
16102.250, 2,1 ml capacity, dosage 0,1 ml

33875.000

**Instructions:** After each use, the syringe should be cleaned. Before cleaning the washer must be removed to allow a long shelf life. Do not use vinegary or citrus detergents for cleaning the syringe. The plexi barrel can be sterilised up to 120°C.

### **Adjusting the dosage for the „MUTO“®-Tuberkulina 50 S, 2,1 ml**

The required dosage can be fixed by moving the dosing sleeve back and forward, pushing the pin into the desired position.

## Spare parts

Item No.:	Description	Spare part No. for 33870.000 (5 ml)	Spare part No. for 33875.000 (2,1 ml)
1	Needle mount, nickel-plated	16102.250	33875.050
2	Gasket for needle mount	16220.040	16220.040
3	Plexi barrel	33870.010	33875.010
4	Ring, nickel-plated	33870.040	33870.040
5	Piston lining	33870.030	33870.030
6	Plunger, stainless	33870.020	33875.020
7	Setscrew for piston, stainless	33870.070	33870.070
8	Plunger rod, nickel-chrome-plated	33870.050	33875.030
9	Setscrew for tension screw, stainless	33870.060	33870.060
10	Tension screw, nickel-chrome-plated	16360.210	16360.210
5-10	Complete plunger rod	33870.700	33875.700
11-14	Complete dosage sleeve, nickel-chrome-plated	33870.560	33875.560
15	Locking screw, nickel-chrome-plated	16360.370	16360.370
16	Spring, nickel-chrome-plated	16360.330	16360.330
17	Grip part large	33870.670	33875.670
18	Complete grip, nickel-chrome-plated	33870.660	33875.660
19	Screw for ratchet	16360.250	16360.250
20	Ratchet	16300.240	16300.240
21	Spring for ratchet	16300.250	16300.250
19-21	Ratchet set with accessories	16300.760	16300.760
22	Small grip part, nickel-chrome-plated	16360.680	16360.680

## **Sterimatic set for „MUTO“® - Tuberkulina**

### **Sterimatic set for the „MUTO“®-Tuberkulina**

33871.000

Automatic needle sanitising system for attaching to our „MUTO“®-Tuberkulina. The safer, cleaner, economical way to inject all livestock. Each cap will give you 100 automatic disinfections and will last for 3 days after opening.

Set consisting of:

#### **Disinfection cap (5 pieces)**

33871.200

#### **Sterimatic sleeve**

33871.020



Recommended needle  
(not included in the set)

#### **TBC-needle with Luer-Lock mount**

0,6 x 5 mm, stainless

33825.000



#### **Needle mount with Luer-Lock mount**

included in the delivery of „MUTO“®-Tuberkulina syringe,  
nickel-plated

16102.250

#### **Adaptor for the sleeve**

for the use of the sterimatic system, nickel-plated

33871.100



**Please visit our website**

**[www.hauptner-herberholz.de](http://www.hauptner-herberholz.de)**



## Tuberculin accessories

### **„Syntena“-TT cartridge syringe**

with automatic dosage of 1/10 ml, in plastic case, with 2 vials containing 6 needles each.

The case also has fittings for 4 TT cartridge (1,8 ml), now with better case

for right hander

33890.000

for left hander

33891.000



### **TT syringe „Perpendo“**

2 ml capacity, with interchangeable glass barrel and metal plunger -not for cartridges-

with bayonett fitting

33861.000

with Luer-Lock mount

33862.000

„Perpendo“-glass barrel, individually packed

33861.300



### **TT needle**

with Luer-Lock mount, 5 mm long, 0,6 mm Ø, stainless

33823.000



### **TT needle**

with bayonett fitting, Prof. Dr. Götze's model, 5 mm long, 0,6 mm Ø, stainless

33863.000



### **TT needle**

with Luer mount and metal hub, 16 mm long, Ø 0,5 mm

33824.000



### **6 TT needles**

Plastic vial with 6 TT needles for syringes Syntena, stainless

33872.000



### **TT set II**

in plastic case containing:

- 1 MUTO-Tuberkulina 50 S syringe 33870.000
- 1 analog TT calliper 33869.000
- 10 TT needles with plastic hub Luer-mount 33824.000
- 1 Sterimatic automatic needle sanitising system complete with 5 caps 33871.200 and adaptor 33871.100

33877.000

## Tuberculin accessories

### **Analogue TT calliper**

without dial reading, very high quality, high precision  
33869.000

### **Digitale TT calliper**

very high quality, high precision, with digital display  
33869.700



Cutimeters or TT-callipers are used by veterinarians to provide an accurate measurement:

- Swelling of the skin in cattle after tuberculinisation is the most important diagnosis of an infection
- Swelling of the skin by measuring wrinkles in the skin or ears of laboratory animals because of allergic reactions
- Measuring of teat conditions in milking animals before and after milking and morphologic changes

## Self-refilling syringes for mass vaccination with Luer-Lock mount

Adapted for poultry, cattle and small animals. Most minute quantities, such as 0,05 ml up to 1,0 ml and viscous iron solutions are easily administered. In use up to 800 injections per hours possible. The self-refilling syringe can be sterilised fully assembled in autoclave up to 121°C.

### **Self-refilling syringe**

complete with tubing, mount and bottle holder

Content	adjustable from	dosages	
1 ml	0,1-1 ml	0,05 ml	33831.000
2 ml	0,3-2 ml	0,10 ml	33832.000
5 ml	0,5-5 ml	0,50 ml	33835.000
10ml	1,0-10ml	1,00 ml	33839.000

### **Glass barrel (for both models)**

1 ml	33831.010
2 ml	33832.010
5 ml	33835.010
10ml	33839.010

### **Spare washer set**

consisting of 2 valve balls, 2 springs and washers for valve and barrel

1 ml	33831.500
2 ml	33832.500
5 ml	33835.500
10ml	33839.500

### **Self-refilling syringe**

identical type as above, but with tubing and mount and without bottle holder

33839.950



## Record syringes



### **Record syringes**

with metal plunger, simple model, sterilisable up to 200°C, with interchangeable, calibrated barrels and plunger

2 ml, Record mount	15810.000
- glass barrel	15810.010
5 ml, Record mount	15820.000
- glass barrel	15820.010
10 ml, Record mount	15830.000
- glass barrel	15830.010
20 ml, Rekord mount	15840.000
- glass barrel	15840.010
2 ml, Luer-Lock mount	15812.000
- glass barrel	15812.010
5 ml, Luer-Lock mount	15822.000
- glass barrel	15822.010
10 ml, Luer-Lock mount	15832.000
- glass barrel	15832.010
20 ml, Luer-Lock mount	15842.000
- glass barrel	15842.010

### **Adapter for injection syringes**



Inside thread, outside Hauptner	16513.000
Inside thread, outside Record	16516.000
Inside thread, outside Luer-Lock	16517.000
Inside thread, outside Luer-Slip	16518.000
Inside thread, outside Record-Lock 1	16519.000
Inside thread, outside Record-Lock 2	16520.000
Inside Luer-Lock, outside Record	16525.000

### **Tubing mounts for injection syringes, nickel-chrome-plated, if Luer-Lock mount**

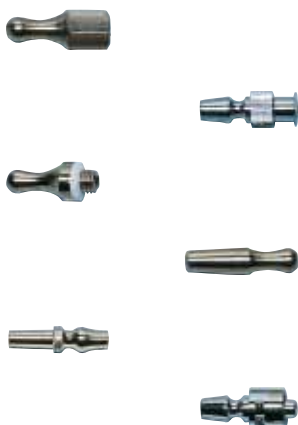

for syringes with thread mount	16502.000
for syringes with Luer-Lock mount	16510.000
for cannulas with thread mount	16505.000
for cannulas with Hauptner mount	16506.000
for cannulas with Luer mount	16509.000
for cannulas with Luer-Lock mount	16511.000

## Plexiglass syringes

Genia-syringes made of plexiglass, with smooth plunger rod, unbreakable

### Plexiglass syringe

ml	with Luer-Lock mount	screw-on mount
5	16102.000	16105.000
10	16112.000	16115.000
20	16122.000	16125.000
30	16132.000	16135.000
50	16142.000	16145.000
100	16152.000	16155.000
200	16162.000	16165.000



ml	plexiglass barrel	washers for metal plunger	metal plunger
5	16100.010	16100.060	16100.050
10	16110.010	16100.060	16100.050
20	16120.010	16120.060	16120.050
30	16130.010	16130.060	16130.050
50	16140.010	16140.060	16140.050
100	16150.010	16150.060	16150.050
200	16160.010	16150.060	16150.050



**Further spare parts on request!**

### Needle mounts for Genia-syringes

nickel-plated

#### Record mount

16101.250

#### Luer-Lock mount

16102.250

#### Screw-on mount

16105.250

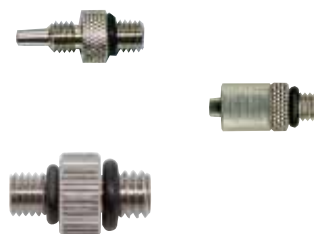

#### Washers for needle mounts

16220.040



**Please visit our website**

**[www.hauptner-herberholz.de](http://www.hauptner-herberholz.de)**

## Elplex plastic syringes

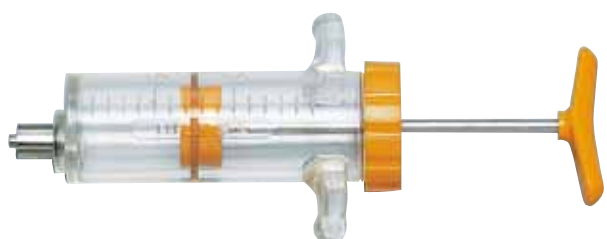

### **Elplex-plastic-syringes**

ml	Luer-Lock mount	screw-on mount	washers
5	15981.000	15991.000	16100.060
10	15982.000	15992.000	16100.060
20	15983.000	15993.000	16120.060
30	15984.000	15994.000	16130.060
50	15985.000	15995.000	16140.060



### **Luer-Lock mount Monobloc nickel-plated**

15980.250

## Syringes with metal plunger



### **Janet syringe**

with 100 ml capacity, interchangeable glass barrel, with Hauptner mount and tube clip

14881.000



### **Glass barrel for Janet syringe**

100 ml

14881.010



### **Janet syringe**

with 200 ml capacity, interchangeable glass barrel, with Hauptner mount and tube clip

14882.000

### **Glass barrel for Janet syringe**

200 ml

14882.010



### **Janet metal syringe**

with 200 ml capacity, all metal, with Hauptner mount and tube clip

14920.000

Depending on the medication of the uterus (liquid, pastry or pills) the further treatment will follow. For liquid medicaments, which are mostly used for the rinsing of the uterus, the Janet syringes 14881.000, 14882.000 and 14920.000 in connection with an uterus catheter are recommended.



## Drenchers

### Plastic drencher

with drenching needle, dosage continuously adjustable, interchangeable plastic barrel, expandable to different sizes

ml	needle	
20	105 x 6 mm Ø	16402.000
50	105 x 10 mm Ø	16405.000
70	105 x 10 mm Ø	16407.000
150	180 x 10 mm Ø	16410.000
250	180 x 10 mm Ø	16411.000



### Cylinder for exchange

20 ml, complete with plunger, washer, spring and adapter for 16402.000 - 16411.000

16412.000

### Cylinder for exchange

50 ml, complete with plunger, washer, spring and adapter for 16402.000 - 16411.000

16415.000

### Cylinder for exchange

70 ml, complete with plunger, washer, spring and adapter for 16402.000 - 16411.000

16417.000

### Cylinder for exchange

150 ml, complete with plunger, washer, spring and adapter for 16402.000 - 16411.000

16420.000

### Cylinder for exchange

250 ml, complete with plunger, washer, spring and adapter for 16402.000 - 16411.000

16421.000

### Drenching needle

for plastic drencher

ml	needle	
20	105 x 6 mm Ø	16402.020
50	105 X 10 mm Ø	16405.020
70	105 x 10 mm Ø	16405.020



### Drenching needle

for plastic drencher

ml	needle	
150	180 x 10 mm Ø	16410.020
250	180 x 10 mm Ø	16410.020



### Spare washers for cylinder

for plastic drencher

ml		
20		16402.010
50		16405.010
70		16407.010
150		16410.010
250		16411.010



## Drenchers



### **Drench-Matic**

with antiblock-valve, no blocking of valve during drenching, even if there are viscous liquids, 0,5 - 20 ml, with 1,7 m plastic tubing, without bottle

16456.000

### **Spare part set**

with valve, valve spring and O-ring for piston

16456.500



### **Automatic drencher**

for connecting with a container, max. 70 ml capacity, automatic refilling cylinder, with drenching needle 105 mm x 10 mm Ø

16427.000

### **Set valve with washers and spring**

for automatic drencher

16427.020

### **Set washers**

for automatic drencher

16427.030



### **Backpack container with braces**

5 l capacity, with lid and olivary body in the lower part, graduation liter by liter on each side, for automatic drenchers

16430.000

### **Drenching syringes**

made of strong plastic material, with adapter for Luer-Lock mount, division 10 ml, excluding drenching tube

300 ml

16461.100

450 ml

16465.100



### **Drenching syringe**

300 ml, made of strong plastic material, visible division in 10 ml on the cylinder, syringe complete with needle

16461.000

### **Adapter for drenching syringe 16461**

with inside screw-on mount for needle mounts with outside thread: 16100.250, 16101.250, 16102.250, 16105.250

16461.260

### **Needle mount Luer-Lock**

for drenching syringes 16461.000 and 16461.100, nickel-plated

16102.250

### **Drenching needle with Luer-Lock mount**

for small animals, ca. 10 cm long, Ø ca. 12 mm. When using on syringes 16461.000 and 16461.100 the needle mount 16102.250 is required

16530.000



## Re-usable needles

- ✓ due to special Bison-grinding the point is longer and sharper
- ✓ high-quality, made of stainless steel
- ✓ thick-wall needle tube with high stability and extreme elasticity
- ✓ large formed needle mount
- ✓ delivery in boxes of **10 pieces**



### with thread mount

needle length	Ø mm	1,0	1,2	1,4	1,6	1,8	2,0
10 mm	16952. ...	.100	.200	---	---	---	---
15 mm	16952. ...	.110	.210	.310	.410	.510	.710
20 mm	16952. ...	.120	.220	.320	.420	.520	.720
25 mm	16952. ...	---	.230	.330	.430	.530	.730
35 mm	16952. ...	---	---	.030	.040	.050	.070

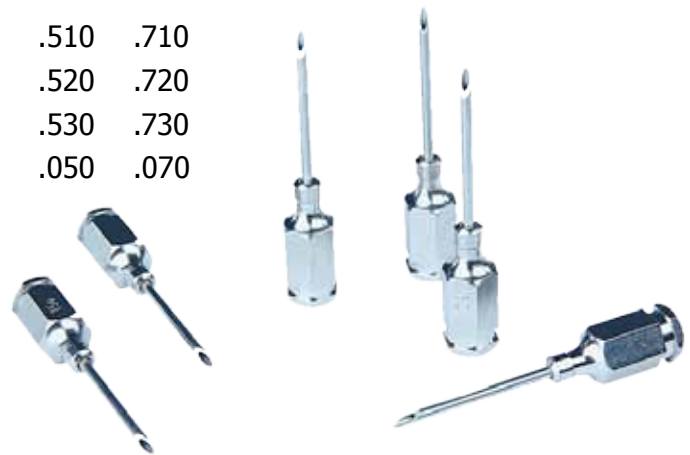

### with Luer-Lock mount

needle length	Ø mm	1,0	1,2	1,4	1,6	1,8	2,0
15 mm	17051. ...	.110	.210	.310	.410	.510	.710
20 mm	17051. ...	.120	.220	.320	.420	.520	.720
25 mm	17051. ...	.130	.230	.330	.430	.530	.730
35 mm	17051. ...	.010	.020	.030	.040	.050	.070

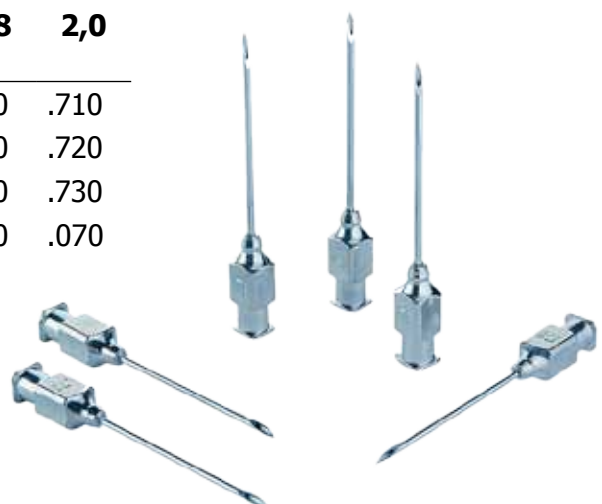

For larger quantities we can also offer the more economic S-Line needles 17053..., in different measurements. Please contact us and we will make a special offer for you.

## Disposable syringes and needles

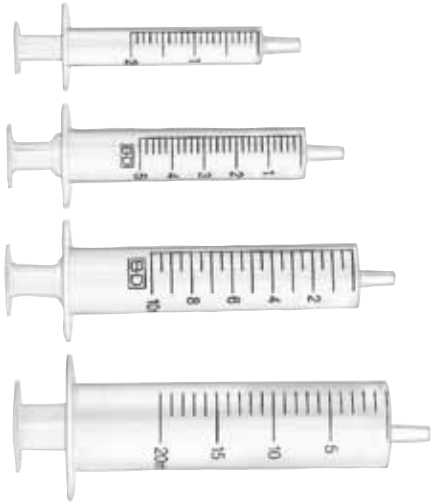

### Disposable syringes

ml	unit	
2	100	14002.000
5	100	14005.000
10	100	14010.000
20	80	14020.000
50	30	14050.000



### Disposable needles

with plastic Luer-mount, packed per 100

Ø	length	
0,6	25 mm	16800.060
0,7	32 mm	16800.070
0,8	40 mm	16800.080
0,9	40 mm	16800.090
1,2	40 mm	16800.120
1,2	75 mm	16800.127
1,2	100 mm	16800.129
1,4	40 mm	16800.140
1,5	30 mm	16800.150
1,5	50 mm	16800.155
1,5	100 mm	16800.159
1,6	40 mm	16800.164
1,8	40 mm	16800.184
1,8	60 mm	16800.180
1,8	80 mm	16800.188
2,0	40 mm	16800.204
2,0	80 mm	16800.200

## Infusion sets



### Infusion set

consisting of rubber stopper with air intake tube, adaptor and needle 17112.000

16712.000



### Perfudrop-Air

disposable infusion set with Luer-Lock mount, with built-in ventilation and bacteria filter, 15 mm DIN filter, drip area PVC-free, with regulator

16730.000



### Double bulb

rubber, for acceleration of infusion by horses

25112.000

## Bleeding needles

### **Bleeding needle with Luer-Lock mount**

Schleißheim's model, 90 mm long, 2,1 mm Ø, stainless  
18001.000



### **Bleeding needle with Hauptner mount**

Troester's needle with protective cap, length 80 mm,  
5 mm Ø, stainless  
18050.000



### **Bleeding needle with Luer mount**

Troester's needle with protective cap, length 80 mm,  
5 mm Ø, stainless  
18053.000



### **Bleeding needle with Luer mount**

length 70 mm, 4 mm Ø, stainless  
18091.000



### **Bleeding needle with Record mount**

length 65 mm, 2,5 mm Ø, stainless  
18051.000



### **Bleeding needle with Record mount**

length 100 mm, 2,5 mm Ø, stainless  
18052.000



### **Bleeding needle with Luer mount**

length 65 mm, 2,5 mm Ø, stainless  
18054.000



### **Bleeding needle with Luer mount**

length 100 mm, 2,5 mm Ø, stainless  
18055.000



### **Bleeding needle with Luer mount**

length 80 mm, 3 mm Ø, stainless  
18061.000



### **Bleeding needle with Hauptner mount**

length 80 mm, 3 mm Ø, stainless  
18060.000



## Needles with Hauptner mount



### **Needle for sacral- and extradural anaesthesia**

100 mm long, 1,8 mm Ø, stainless

06290.000



### **Infiltration needle**

Dr. Wille's model, with side openings and small outlet,  
140 mm long, 1,8 mm Ø, stainless

16901.000



### **Needle for epidural anaesthesia**

60 mm long, 2 mm Ø, stainless

16970.000



### **Needle for extradural anaesthesia**

model of the veterinary university of Hannover, 92 mm  
long, 2,5 mm Ø, stainless

16971.000



### **Needle for Jodipin injection**

45 mm long, 2,8 mm Ø, stainless

16991.000



### **Needle for intravenous injection**

70 mm long, 2,5 mm Ø, stainless

17110.000



### **Needle for udder infusion**

probe ended, 130 mm long, 1,8 mm Ø, stainless

17181.000



### **Needle for udder injection**

pointed, 130 mm long, 1,8 mm Ø, stainless

17182.000

**Please visit our website**

**[www.hauptner-herberholz.de](http://www.hauptner-herberholz.de)**

## Needle with Luer-Lock mount

### **Infiltration needle**

Dr. Wille's model, with side openings and small outlet,  
140 mm long, 1,8 mm Ø, stainless

16900.000



### **Needle for epidural anaesthesia**

60 mm long, 2 mm Ø, stainless

16972.000



### **Needle for Jodipin injection**

45 mm long, 2,8 mm Ø, stainless

16992.000



### **Needle for intravenous injection**

70 mm long, 2,5 mm Ø, stainless

17112.000



### **Probe ended needle**

60 mm long, 1,5 mm Ø, stainless

17183.000



### **Probe ended needle**

45 mm long, 2 mm Ø, stainless

41652.000



### **Needle for udder injection**

pointed, 130 mm long, 1,8 mm Ø, stainless

17184.000



### **Anal sac needle**

40 mm long, 1,5 mm Ø, curved, stainless

17191.000



### **Eye needle**

33 mm long, 0,67 mm Ø, curved, stainless

31011.000



## Various needles

### **Needle for extradural anaesthesia**

Luer mount, model of the veterinary university of  
Hannover, 92 mm long, 2,5 mm Ø, stainless

16973.000



### **Lachrymal cannula for horses**

for rinsing the nasolacrimal duct, 85 mm long, stainless,  
with tubing mount, Luer-Lock mount

31030.000





## Blood taking

### **Tourniquet**

padded, with metal ring and needle, 1,80 m long

18290.000

### **Chain tourniquet**

Prof. Witte's model, 1,70 m long, nickel-plated

18580.000

### **„Stripp-Quick“ tourniquet**

for small animals, with rubber string and clamp-loose-appliance for one-hand operation

18590.000

### **Rubber string, 60 cm, single**

18590.010

## Venoject blood taking system

The Venoject blood taking system avoids the risk of haemolysis and coagulation as well as contact with air or foreign bodies. It consists of a vacuum test tube, a sterilised disposable bleeding needle and a plastic holder for connecting tube and needle.



### **Venoject-holder**

for 5 and 10 ml test tube, re-usable, for the connection of the test tube and the needle

18400.000

### **Disposable needle**

without latex cap, for single use on large animals, 1,2 mm Ø, 38 mm long, sterile

18418.000



### **Test tubes**

made of plastic

Test tube contents	plain	Natrium-heparinised	EDTA K3 liquid
Examination	serum	blood plasma	blood picture
Stopper colour	red	green	violet
5 ml	18405.010	-	18405.050
10 ml	18410.010	18410.030	

### **Minimum quantity 1.200 pieces**

Please ask also for other blood taking systems, for example Quick-Fit safety system (easy and practical handling)



## Kima blood taking system

The Vacutest –Plast is a test tube made of special plastic material with inside vacuum for taking blood. It has an extremely high elasticity as well as a high shock resistance and high tensile strength. Extensive research has resulted in the production of gas-proof plastic material. The Vacutest system features a unique patented safety cap on both the 13 mm and 16 mm tubes. The outer portion of the safety cap on the 16 mm closure features an innovative thin design which enables the user to easily switch between the 13 mm Vacutest tube and the 16 mm Vacutest tube while using the same needle holder.

### **Disposable holder**

for the connection of the test tube and the needle  
100 pieces packed in bags

18430.000

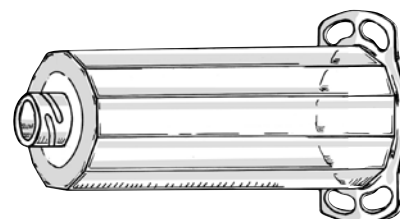

### **Disposable needle**

for blood taking, sterile, without latex cap, 18 G x 1 1/2"

18435.000



### **Disposable needle**

for blood taking, sterile, without latex cap, 18 G x 1"

18436.000

### **Disposable needle**

for blood taking, sterile, with latex cap, 18 G x 1 1/2"

18437.000



### **Disposable needle**

for blood taking, sterile, with latex cap, 18 G x 1"

18438.000

### **Test tubes**

made of plastic

Test tube contents	Clot activator	Lithium heparin anticoagulant	K3 EDTA Anticoagulant
Stopper colour	red	green	violet
	18431.010	18431.030	18431.050

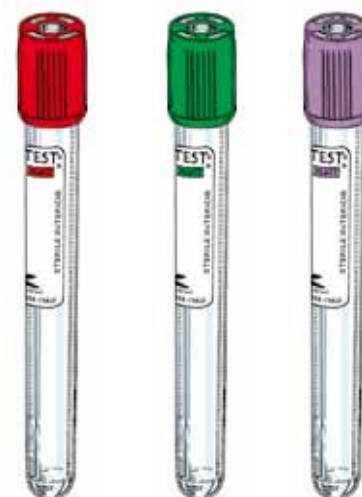

**This is just a short overview about our Kima blood taking system. For further information please contact our sales department!**

## Heat detectors

### **Heat detector**

with analog display for determination of the optimal time of insemination of cattle, all heat detectors will be delivered in a bag for safe keeping.

- saves on cost as there is no need for a second insemination
- economic, makes it possible to identify the heat of difficult animals
- easy handling as the probe only needs to be inserted into the vagina and after pushing the button the value of the ohm will be immediately displayed, this indicates the stage of the heat



### **Heat detector**

for cattle, with 2 high sensitive ring electrodes, length of the sonde ca. 36 cm

01610.000

### **Heat detector for cattle**

For heat diagnosis of cattle by measuring the electric resistance of the mucus of the uterus. That the diagnosis is correct and provided on time is of great importance to the success and efficiency of a farm. Especially if artificial insemination is used.

**0 - 35 ohm**  
**35 - 40 ohm**  
**over 40 ohm**

**too early for insemination**  
**optimal period (special marking)**  
**too late for insemination**

The optimal time of insemination of cattle is between 35 and 40 ohm, which is marked on the scale. By reaching this value, the cow is in the optimal period for insemination, which lasts for 6 - 8 hours. There can also be individual differences. If you get a value of 35 and 40 ohm the optimal time of insemination has been reached, the cow can now be artificially inseminated. It is also the optimal time for the mating. If the value of ohm is under 35 ohm, wait for a few hours and then repeat the measurement, for the accurate determination of the optimal time of insemination.

If you get a value over 45 ohm, it is too late for insemination and you have to wait for the next period of heat.

### **Technical characteristics**

- Heat detector with built-in and rechargeable battery for 230 V and charging cable
- according to VDE instructions and double insulated
- CE certificated
- ambient temperature 0 - 40°C
- electric shock protection class II
- type IS, 110/220V, 3 VA, 47-60 Hz

## Heat detectors

### Heat detector

with analog display for determination of the optimal time of insemination of sows, all heat detectors will be delivered in a bag for safe keeping.

- saves on cost as there is no need for a second insemination
- economic, makes it possible to identify the heat of difficult animals
- easy handling as the probe only needs to be inserted into the vagina and after pushing the button the value of the ohm will be immediately displayed, this indicates the stage of the heat



### Heat detector

for pigs, with 3 high sensitive ring electrodes, length of the sonde ca. 18 cm

01612.000

### Heat detector for pigs

For heat diagnosis in pigs by measuring the electric resistance of the mucus of the uterus. The correct and timely diagnosis is of great importance to the success and efficiency of the farm. Especially, if there is artificial insemination used.

**0 - 30 ohm**  
**30 - 40 ohm**  
**over 40 ohm**

**too early for insemination**  
**optimal period (special marking)**  
**too late for insemination**

The optimal time of insemination of pigs is between 30 and 40 ohm. If the value of ohm is under 30 ohm, wait for a few hours and then repeat the measurement, for the accurate determination of the optimal time of insemination. If you get a value over 45 ohm, it is too late for insemination. You will need to wait until the next heat, in 3 weeks time, until you have the next optimal time for insemination. Whilst the heat detector gives an overview of the oestrus cycle, but the heat detector should only be used, when the sow is in standing oestrus. The heat detector can only be used if the sow shows acceptance reflex. In this situation it does not matter by which device this reflex is activated.

### Technical characteristics

- Heat detector with built-in and rechargeable battery for 230 V and charging cable
- according to VDE instructions and double insulated
- CE certificated
- ambient temperature 0 - 40°C
- electric shock protection class II
- type IS, 110/220V, 3 VA, 47-60 Hz

## Instructions for using the heat detector

The heat detector consists of a measuring box with a built-on probe made of plastic. For measuring the electric resistance of the mucus of the uterus of cattle, 2 high sensitive ring electrodes are built-in the probe.

In the measuring box, there is an indicating instrument for showing the value of ohm. To use the heat detector, push the two buttons below the indicating instrument.

The button „EIN“ is used for the implementation of measurement and the button named „TEST“ is used in combination with the button „EIN“ for controlling the battery charging. The battery can be recharged with the built-in battery recharger by using the charging cable.

### 1) Checking the battery:

Please press both buttons („TEST“ and „EIN“) at the same time.

If you see a needle deflection to 60 ohm the heat detector is ready. If the needle drops down under 58 ohm, the battery of the heat detector for cattle has to be recharged for 10 hours on 220 v and 20 hours on 110 v. The charging time of the heat detector for pigs takes 8 hours on 220 v and 14 hours on 110 v.

### 2) Please clean the genital of the animal carefully before starting the measurement on the examined animal.

3) The Vulva can be dried by using a tissue. Insert the probe into the vagina without using an anti-blocking agent and try to avoid any contamination of the probe. Our experience has shown us, that you will get reliable values, if you press the probe slightly to the bottom of the vagina nearby the cervix. The top has to be held down and then you have to press the button „EIN“ and the electric resistance will be shown.

4) The shown value is an indicator for the stage of the heat. If the needle stays between 25-30 ohm, it shows that the heat has began. If the needle stays between 30 and 40 ohm, the animal is in the optimal time for insemination. This optimal time takes 6-8 hours in general, disregarding individual differences. If the needle goes over 40 ohm, the heat is at his end and in the most cases it is too late for a succesful insemination.

5) The measurement can be assured by controlling and examining the ovary. A hard follicle on the ovary indicates, that it is too early for an insemination (measurement results 25-30 ohm). A soft and elastic follicle shows the optimal time for insemination (measurement results 30-40 ohm). This examination is definitively required, because the heat detector will also indicate the optimal time in heat (30-40 ohm), even if there are clearly tangible cysts on the ovary.

6) If the value of the measurement is over 50 ohm, there can be an early pregnancy, if there was an insemination in advance.

7) In the time without heat the values can also be about 50 ohm and more.

8) After the measurement the probe has to be cleaned with warm water and disinfection liquid (for example 2% caustic lye of soda). Afterwards washing it up with cold water, drying it and disinfecting it with 70% alcohol. Then you can do the measurement on the next cow. This cleaning avoids any further infection from one animal to another.

9) The electrodes should also be cleaned after several uses with alcohol and a disposable cloth.

## **Artificial insemination instruments**

### **Prof. Dr. Götze's tube speculum**

light metal, for cows, 38 cm long, inner diameter 4 cm,  
cylindrical

42955.000



### **Prof. Dr. Abelein's tube speculum**

light metal, 37 cm long, inner diameter 4,4 - 7,5 cm,  
chrome-plated, conical

42956.000



### **Tube speculum**

nickel-plated brass, for pigs and cows, 40 cm long, inner  
diameter 2,5 cm, cylindrical

42959.000



### **Tube speculum**

nickel-plated brass, cylindrical, built-in lamp Prof. Dr. v.  
Mickwitz's model, for light attachment 42960.000

for pigs (400 x 26 mm)

42958.000

for calves and sheep (300 x 28 mm)

42966.000



### **Light attachment**

complete with 2 batteries, suitable for tube specula  
42958.000, 42966.000

42960.000



### **Glide slime**

to make hands and arms slippery for rectal and vaginal  
examinations, excellent skin protection, very abundant,  
1.000 ml

47520.000



### **Boar Scent Spray**

80 ml, to determine the best moment for mating or  
artificial insemination in sows and young sows, stimulates  
sows, max. 2 sec. near the animal

10630.000



**Artificial insemination accessories**



**Artificial vaginas**

for bulls, complete with body, valve, inner tube, semen collection vial 15 ml, director cone with warming bag  
body 30 cm

43765.000

body 41 cm

43766.000



**Artificial vagina**

for sheep and goats, complete with valve, inner tube 300 mm long and semen collection vial 4 ml, body 16 cm

43842.000



**Artificial vagina**

for horses, complete

43815.000

consisting of:

Tube 44 cm long

43815.110

Semen collection vial 250 ml

43816.000



Rubber ring for the body

43817.000

Inner tube, 970 mm long

43818.000

Leather holder

43819.000



**Air conditioned box for liquid semen**

18 litre capacity, temperature + 17°C, with connection for 12 V-car battery, with transformer 12 V/230 V, which makes it possible to use the appliance via the AC network in your laboratory or barn, exterior dimensions: ca. 40 x 46 x 26 cm (width x height x depth)

43711.000

## French type straws

### French type straws

0,25 / 0,5 ml

best quality - reliable - universal



Colour	0,25 ml	0,5 ml
Clear	43707.010	43708.010
Red	43707.040	43708.040
Green	43707.050	43708.050
Blue	---	43708.060
Grey	43707.070	43708.070
Purple	43707.080	43708.080
Yellow	43707.090	43708.090
Pink	43707.100	43708.100
Turquoise	43707.130	43708.130
Orange	43707.140	43708.140
Sky-blue	43707.150	43708.150
Salmon	43707.160	43708.160
Beige	43707.180	43708.180
Pistachio green	43707.200	43708.200

Translucent colours	0,25 ml
Red	43707.044
Green	43707.054
Blue	43707.064
Grey	43707.074
Yellow	43707.094
Orange	43707.144

Packing unit for 0,25 ml

Carton 100.000 pieces  
Bag 2.000 pieces

Packing unit for 0,5 ml

Carton 50.000 pieces  
Bag 2.500 pieces

**Please visit our website**

**[www.hauptner-herberholz.de](http://www.hauptner-herberholz.de)**

## Artificial insemination accessories

### Containers for semen storage and transport



	43720.000	43721.000	43722.000
Net capacity l	4,1	9,3	35,9
Weight empty kg	4,2	9,0	14,7
Weight full kg	7,5	16,5	43,7
Overall height mm	433	455	688
Outside-Ø mm	245	368	480
Neck tube-Ø mm	51	51	89
Static holding time days	42	93	211



### Goblets

plastic for storage of French type straws

	43730.000	43731.000
Goblet levels	1	2
Canister height mm	110	270
Canister inner-Ø mm	37	66
Quantity of canisters	6	6



### Container

for storage and transport of liquid nitrogen

	43715.000
Net capacity l	35
Weight empty kg	13
Weight full kg	41,5
Overall height mm	433
Inner height mm	526
Outside-Ø mm	245
Neck tube-Ø mm	50
Static evaporation day	0,25



## **Artificial insemination accessories**

### **Thawing unit MT 30/54**

with very robust, electronic control, diode light system for control and temperature indication. Central built-in thawing chamber with lift.

Temperature: +38°C (other temperature setting upon demand)

Accuracy: +/- 0,2°C, Power supply: 12 V (car battery)  
43740.000



### **Thawing unit MT**

as 43740.000, with central, built-in thawing chamber and lift, without electronic temperature control

43741.000

### **CITO Thawer**

rugged construction made of ABS plastic. Hinged lid with cover seal, vacuum insulated thawing chamber with basket for straws. Constant thawing rate of 39°C through thermostatic control, LEDs indicate activation of heating cycle and reaching of operation temperature

Accuracy: +/- 0,2°C, Power supply: 12 V (car battery)  
43742.000



### **Insemination gun**

stainless steel, universal model for all types of semen straws, inner part 45 cm, outer part 48 cm

43795.000



### **Universal sheaths**

pack of 50 pieces

43796.000



### **Disposable insemination pipettes**

plastic, 44 cm, 5,5 mm Ø, 25 pieces

43791.000



### **Insemination glove**

shoulder length, 5 fingers, elastic and sensitive, 100 pieces in one package

47517.000



## Insemination kit



### **Insemination kit**

complete, composed of: Plastic insemination case, CITO thawer 43742.000, 1 Quickblock AL gun 43751.000, 100 universal sheaths 43796.000, speculum Varikon 43752.000, 1 box of gloves 47517.000, cutter 43753.000, tweezers 43754.000 and 43755.000 and clamp 43756.000

43750.000



### **Varikon, speculum made of plastic**

unbreakable, sterilisation up to 150°C, length 385 mm, conical shape

43752.000

### **Disposable hygienic covers**

for speculum Varikon, roll with 500 pieces

43752.500



### **Cutter for semen straws**

43753.000



### **Tweezers for semen straws**

angular shape, 20 cm

43754.000



crank chape, 10 cm

43755.000

### **Clamp for canister**

43756.000

## Ultrasound unit

### **Preg-Tone ultrasound unit**

Originally RENCO, ultrasound tester for the diagnosis of pregnancy in sows

Pigs: Safe pregnancy diagnosis between the 25th and 75th day after insemination

Sheep: Safe pregnancy diagnosis between the 40th and 80th day after insemination

Delivered complete with cable, battery recharger in transportation box

- handy pocket instrument in a metal case, sized 15 x 7 x 4,5 cm
- easy operation by acoustic signal tones:  
pregnancy = continuous tone  
no pregnancy = intermittent tone

01605.000

### **Battery charger**

01605.020

### **Smooth cable with plug**

01605.070



CE

### **Preg-Tone**

The Preg-Tone ultrasonic device emitted sound waves in the high frequency range, which means ultrasound. The unit measures the amnion fluid which fills the uterus after insemination. The head has to be held on the right side and the ultra sound will be reflected from the fluid. If the uterus does not contain amnion fluid no reflection will be received and that means not pregnant. If the animal is pregnant, you will hear a continuous tone. If the animal is not pregnant, you will hear an intermittent tone. So you can clearly hear, if the animal is pregnant or not.

Place the head between the 2nd and 3rd teat, ca. 3 cm upwards and 45° angled ahead, so that you do not meet the bladder. The sonar beam should pass the animal's spine 1 cm beneath, at the other side. Keep the head good on the skin but not with too much pressure to avoid deforming at the body area. Change also the direction of the beam so that you meet the whole uterus. No signal shows that a smooth contact has not been made. If you place the head too far backward the possibility of meeting the animals bladder is given. This can cause false result because the urine reflects. If you are not sure, please repeat the test after the animal has drained its bladder.

**Please visit our website**

**[www.hauptner-herberholz.de](http://www.hauptner-herberholz.de)**



## Lean-Meater

### **Lean-Meater ultrasound unit**

for measuring the thickness of backfat of sows and boars

- simple quick and accurate
- direct digital display
- range of measurement from 3 to 45 mm
- complete with cable and battery charger in plastic case
- indispensable for modern farm management

Lean-Meater is a handy pocket instrument in a metal case sized 18 x 7 x 2,5 cm.

High accuracy of reading is assured by permanence of display even after the probe has been taken off.

Operating instructions included.

01607.000

The **Lean-Meater** uses pulsed ultrasound to measure total backfat depth of mammals having 1, 2 or 3 backfat layers. The total measurement range and accuracy including skin is 4 - 35 mm +/- 1 digit. The power is provided by a Nickel Metal Hydride (NMH) rechargeable battery. The number of backfat layers is automatically determined and displayed. The instrument is not waterproof, do not submerge. To assemble, connect the probe with the cable and the cable with the instrument. Twist both connector barrels until they snap into locked position. For testing the functionality of the unit, please use the added testing block. If you get a measurement of 25 +/- 1 the Lean-Meater ultrasound unit is in perfect condition and ready to use.

### **Using the Lean-Meater**

Please apply a generous amount of coupling fluid, such as our Hauptner-Herberholz special coupling fluid (01601.200) to the test site. Insufficient coupling fluid is the most common source of error as ultrasound cannot pass through air or air bubbles. Press the power button. Apply the probe to the site, use a gentle pressing/rotating action to force any air bubbles between the skin and probe. It is important that the probe be kept perpendicular to the back. Errors may result if the probe is at an angle. Many have found that the probe is most easily managed, if it is held between the index and middle fingers.

There are 3 read light indicators on the left of the Lean-Meater unit. The top light indicates 1 layer, top and middle lights indicate 2 layers and all 3 lights indicate 3 layers. The skin thickness is included in all cases unless it is thinner than 3 mm, in which case it will be counted as 1 layer. The skin of most mammals does not exceed 3 mm. The read indicators light up when the appropriate number of layers have been found. If read light(s) do not come on, then the skin contact is poor. Use more coupling fluid to remove air bubbles, be sure that the probe is perpendicular to the back. Consistency of probe placement is of great importance in obtaining comparative measurements.

For swine, only site B (see the drawing below) will give an accurate reading of the 3 layers of fat. Values obtained using ultrasonic devices on live animals will generally be different to those measured at slaughter because of differences in measurement sites and fat on a hanging carcass is distorted or cut.

The most accurate spot in which to measure backfat can be found by walking your fingers forward along the hog's flank until you can feel the last rib, then place the probe on this site B, 65 mm from either side of the backbone.

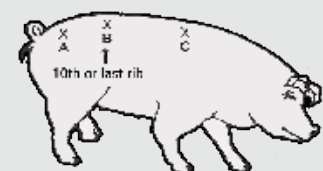

## **Exago**

### **Exago ultrasonic device**

is a portable ultrasonic scanner and convinces because of:

- good portability
- Autonomy
- high image quality
- wide-band probes
- intuitive user interface
- good equipment, e.g. standard equipped doppler

...for flexible and independent work!

01609.000



The Exago was developed in particular for application on horses, cows and for small animals and is designed with the latest technology. It can be used on a trolley in the surgery as well as in the stable. The 8.4 inch screen and the advanced image size allows the user reliable and fast diagnosis. Ultrasound images and video frequencies can be stored directly. The Exago is equipped with standardised connections so that there is the possibility of a bigger screen, a printer or an USB-stick.



01609.140



01609.130



01609.120



01609.110

The probes use the most advanced technology of piezoelectric composites, offering unequalled performances in band width. You will be able to select the optimal probe to optimise the details of observed tissues during the examination.

### **System specifications**

weight: 3250 g with battery, 8,4" screen, alphanumeric keyboard and touchpad, integrated loudspeaker, interchangeable battery, long autonomy (5,5 Std.), intuitive user interface

### **Imaging modes**

B, B/M - mode, CFM: Colour flow mapping, pulsed wave doppler (PW), zoom, cineloop, text and annotations, protocols, measurements and tables, storing clips and images

### **Clinical applications**

abdominal, gynaecology, tendons, obstetrics



## Imago

### **Imago ultrasound scanner**

portable ultrasonic scanner and convinces because of:

- extremely robust
- ultra-light
- high image quality
- wide band probes
- intuitive user interface, touchscreen
- diverse functions

...optimal to work in the stable!



01608.000

The Imago was developed in particular for application on cows, horses, pigs, sheep and goats. It is also suitable for small animals like dogs and cats. The weight is 1,8 kg with battery. Two probes can be stored in the case. The interchangeable battery allows the user a fast, reliable and accurate diagnosis. Ultrasound images and video frequencies can be stored directly. The Imago is equipped with standardised connections for a bigger screen, a printer or a USB-stick.



01608.110



01608.120



01608.130



01608.140

The probes use the most advanced technology of piezoelectric composites, offering unequalled performances in band width. You will be able to select the optimal probe to optimise the details of observed tissues during the examination.

### **System specifications**

Weight: 1800 g with battery, 6,5" screen, touchscreen, long autonomy, interchangeable battery, intuitive user interface, magnesium housing

### **Imaging modes**

B, B+B, B/M - mode, zoom, focus, cineloop, text and annotations, protocols, measurement and tables, storing clips and images, connection of peripherals

### **Clinical applications**

general, gynaecology, tendon, abdominal



## **Exagyne**

### **Exagyne ultrasound scanner**

is a portable ultrasound scanner of the premium class and convinces because of:

- compact and modern method of construction
- multifarious possibilities of investigations
- possibility to work 2 hours with battery
- digital data and image storage
- colour doppler

...for flexible and independent work!

01603.000



The Exagyne was developed in particular for application on small animals and is designed with the latest technology. The Exagyne weighs 7,5 kg and the interchangeable battery has the capacity for 2 hours of use. The 15" screen and the advanced image size allows the user a fast, reliable and accurate diagnosis. Ultrasound images and video frequencies can be stored directly. The Exagyne is equipped with standardised connections for a bigger screen, a printer or USB-stick.



The probes use the most advanced technology of piezoelectric composites, offering unequalled performances in band width. You will be able to select the optimal probe to optimise the details of observed tissues during the examination.

### **System specifications**

Weight: 7,5 kg with battery, 15" screen, powerful computer unit, patient-list and database, postprocessing of images and clips

### **Imaging modes**

B, B+B, B/M - mode,  
CW, PW, CFM, 4D-option, zoom,  
cineloop, CD/DVD-writer, 3 USB, DICOM, RJ45,  
VIDEO/DVI

### **Clinical applications**

abdominal, obstetrics, cardiology, synecology

**Obstetric and embryotomy instruments**



**Sand's calving rope introducer**

light model, stainless, 17,5 cm long

44240.000

**Sand's calving rope introducer**

strong model, stainless, 18 cm long

44241.000



**Kühn's crutch**

modified by Dr. Benesch, without rope, strong model, stainless, 83 cm long

44300.000



**Bahlke's embryotomy wire saw introducer**

stainless, 17,5 cm long

46120.000



**Caemmerer's torsion fork**

with sleeves, nickel-chrome-plated, 70 cm long

44330.000

**Spare sleeves**

for torsion fork 44330.000, pair

44330.100

**Eye hooks**



**Harms' eye hook**

sharp, stainless, 8 cm

44351.000



**Harms' eye hook**

sharp, stainless, 10 cm

44352.000



**Freyberger's eye hook**

flat, 5 cm, stainless

44410.000



**Ostertag's eye hook**

blunt, 5,5 cm, chrome-plated

44380.000



**Double eye hook, model Wien**

14 cm, stainless

44490.000



## Obstetric hooks and forceps

### **Krey-Schöttler's obstetric hook**

sharp, stainless, opened 11,5 cm long, closed 18 cm long

44491.000



### **Hohmann's wire hook**

for piglets, 50 cm, stainless

44720.000



### **Niemand's whelping forceps**

for dogs, 28 cm, stainless

44900.000



### **Farrowing forceps**

for piglets, size of the spoon ca. 60 x 120 mm, stainless, 53 cm

44985.000



## Ring knives

### **Linde's ring knife**

with shaped hand-piece, stainless

45090.000



### **Günther's ring knife**

modified by Tapken, with hook shaped blade, chrome-plated

45140.000



## Calving ropes

### **Calving rope**

0,5 cm Ø, 2 m long, made of nylon, padded, with two loops

43800.000



### **Calving rope**

made of nylon, very soft, 8formed, able to boil, 10 mm Ø, 2 m long, usable as head and feet rope, no strangling possible

43801.000



### **Calving rope**

triple set, with head rope 99 cm and 2 feet rope each 115 cm long, flat, hand-made quality

43802.000



## Calving chains



**Prof. Dr. Götze's leading chain**  
80 cm, made of stainless steel

46150.000



**Calving chain**  
with oval inset link, 80 cm, stainless

46152.500

**Calving chain**  
without oval inset link, 76 cm, stainless

46152.600



**Calving chain**  
with 2 oval inset link, 190 cm, stainless

46154.000



**Calving chain**  
without oval inset link, 152 cm, stainless

46154.600



**Calving chain**  
with 2 adjustable handles, 150 cm, nickel-plated

46159.000



**Calving chain grip**  
ring-shaped, stainless

46155.000



**Traction grip for calving chains**  
rod-shaped, stainless

46156.000

## Wire saw

### **Thygesen's wire saw embryotom**

modified by Prof. Dr. Götze, 85 cm long, nickel-chrome-plated, complete with wire saw 46141.000, 2 barrel shaped hand grips 46060.000 and take apart introducer probe with cleaning brush

46130.000



### **Introducer probe**

take-apart, 50 and 60 cm long, with cleaning brush, stainless

46132.000



### **Cleaning brush**

single

46132.150



### **Schaetz' adjustable embryotomy handle**

with various slits to attach chains, stainless

46180.000



### **Canvas bag**

for embryotome 46130.000

46130.200



### **Prof. Dr. Götze's hand grips or wire saw**

barrel shapes, stainless

46060.000



### **Prof. Dr. Götze's hand grips or wire saw**

open handle, stainless

46061.000



### **Liess' embryotomy wire saw**

10,80 m long

46140.000

3,60 m long

46141.000

100,00 m long, on coil

46142.000



### **Calf puller**

#### **Calf puller**

with support attachment, with coarse thread, with 2 parts, 180 cm long, complete with 2 calving ropes and clamping mechanism 2020

46201.000

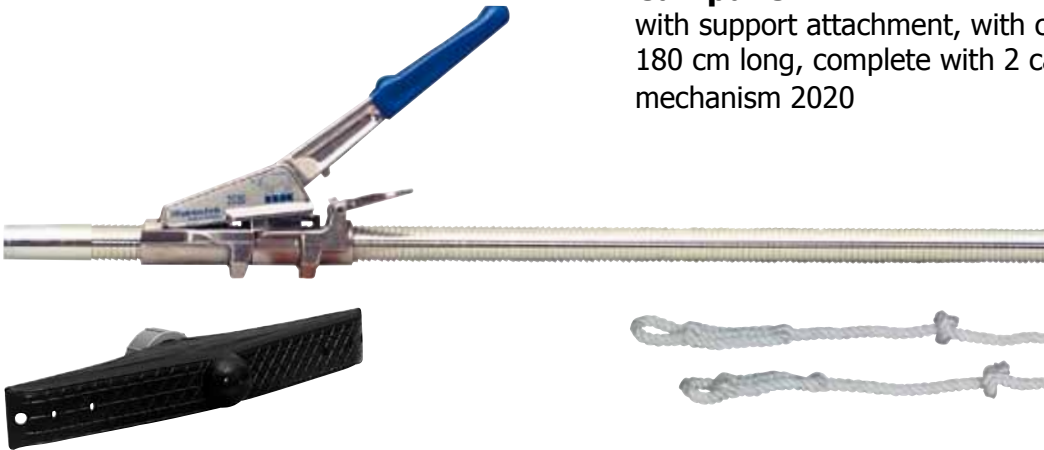

#### **Calf puller**

with support attachment and plastic brackets, with 2 parts, 180 cm long, complete with 2 calving ropes and clamping mechanism 2020

46220.000

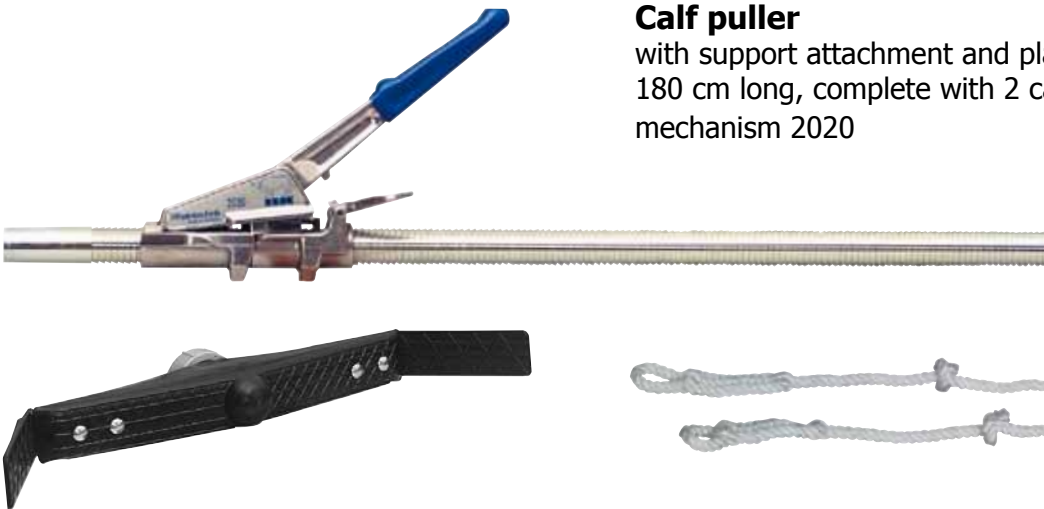

#### **Calf puller**

with ergonomically-shaped support attachment and built-in holding bracket adjustable in width and therefore suitable for all breeds, with coarse thread, with 2 parts, 180 cm long, complete with 2 calving ropes and clamping mechanism 2020

46222.000

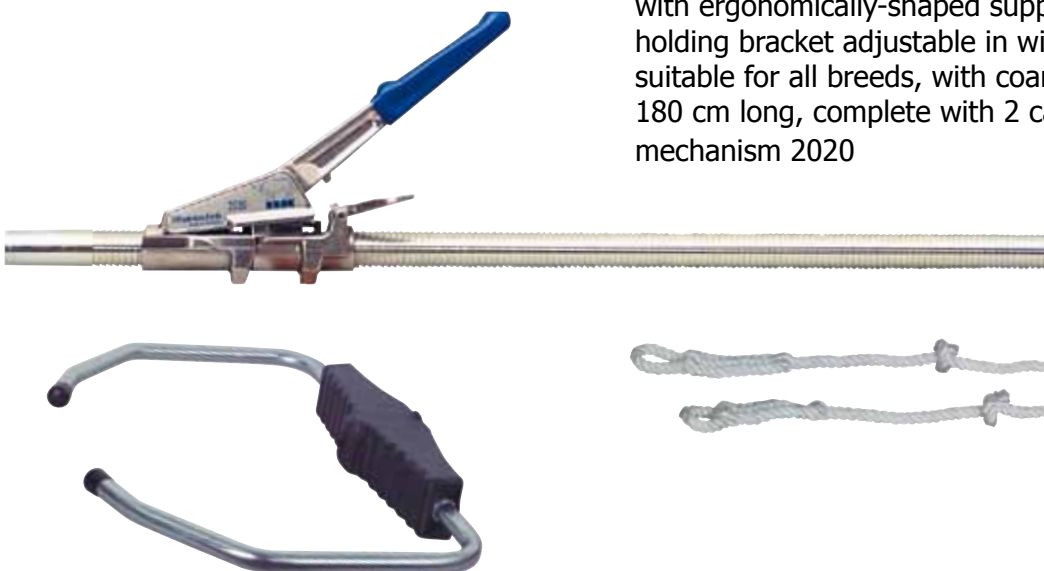

## Spare parts for the calf puller

### Spare ropes

for calf puller (46201, 46220, 46222)

46200.010



### Holding bracket

for calf puller (46201)

46201.500



### Grip complete

46200.080



### Click plate

for models built 1995 and later  
for models built before 1995

46200.090  
46200.091



### Spring and bolt

46200.095

### Winding ring

46200.110



### Support attachment

46200.120



### Complete thread pole

46201.050



In many cases nowadays problems arise during calving, especially when cows have their first calving, it could become necessary to give mechanical help. The calving aid can be used on laying cows as well as on standing cows. Usually the natural calving process should be preferred. Only in case of problems should the mechanical help be used.

At the end of the 180 cm long threaded bar is a rubber support part which is placed beneath the uterus of the cow. The two calving ropes which are included are for looping the rope around each leg, the front leg of the calf (if the calve is laying in opposite direction the rear legs). After this step the calving ropes have to be hooked into the ratchet and the ratchet is moved by pulling the handle back and forward till the ropes are tight. When the contractions have started, please assist during the contractions with careful pulls of the ratchet, until the contraction is finished. Now wait for the next contraction. Because the legs are looped in, the calf can not slip back into the uterus. It remains fixed in the pelvis due to the achieved tension. At the next following contraction continue in the same way, until the calf is fully pulled out.

After the calving process is finished it is important to clean the calving aid carefully and thoroughly. Please dry it afterwards and store it in dry condition.

## Flessa vulva sutures and Flessa needles

### Flessa vulva sutures

with wooden barrels, stainless wire



width	barrels
40 mm	43381.400
50 mm	43381.500
60 mm	43381.600
70 mm	43381.700
80 mm	43381.800

### Brackets

aluminium anodised, 10,5 cm, pair



43391.000

### Flessa needle

for the introduction of Flessa vulva sutures, reversible, stainless



43382.000

### Hauptner's suture needle

for the surgical suturing method in vaginal and uterine prolapsus, 23,5 cm, stainless



43400.000

### Leipold's needle

for inserting Flessa vulva sutures, stainless



43392.000

### Special surgical tape

for perivaginal suturing method, 4,5 m



43420.000

A uterus prolapse can often occur in cows and sheep after giving birth or before. In such cases urgent help is necessary because otherwise it could lead to injuries, trauma or infections with fatal consequences for the animal. For such cases we offer our range of Flessa vulva sutures in different sizes and two types of Flessa needles. The reversible hollow Flessa-needle with handle is one option. Here you separate the hollow needle from the handle that has a thread. With the hollow needle you push from one side through both vulvas. Now you place the wire of the Flessa suture with removed wooden barrels through this hollow needle and screw the wooden barrel onto the free end at the other side of both vulvas. Now draw back the needle and close the second free end with the wooden barrel. The Flessa suture is now positioned. The second option is the simple Leipold's needle. Here you also remove the wooden barrel from one end of the Flessa suture and stick the free wire end into the open end of the needle. Now you can push both parts together, from one side through both vulvas. Because you left the barrel on one side it is already fixed on one side. On the other side please remove the needle and screw-on the left wooden barrel. For a complete vulva suture you always need 3 wires with the corresponding wooden barrels and one pair of aluminium brackets. The brackets are very much recommended to avoid tearing out the sutures. They are supplied in pairs and one bracket should be positioned on each side. The Flessa suture will be threaded-in through the corresponding slits of the brackets on the right and left side of the vulva and finally you screw-on the wooden barrels.

## Wound treatment

### **MEDICLAMP**

The Mediclamps accelerate the drying process of the umbilical cord. They fall off within a short time period and grant the newborn animal perfect protection, that is needed, to avoid bacteria infection. As soon as the umbilical cord has fallen off the Mediclamps seal the other end of it with their permanent pressure. Mediclamps are made of a high quality special plastic material and are designed for a long life and high reusability.

### **MEDICLAMPS**

for calves and foals, single

46691.000



### **Disposable umbilical cord universal**

pack of 100 pieces

46692.000



### **Suture needles**

spring head, curved, triangular, nickel-plated, pack of 12 pieces

20600.090





### **Mathieu's needle holder**

stainless

14 cm long

17 cm long

 97500  
 97501





### **Artery forceps**

long jaws, stainless, 14,5 cm long

straight

curved

 97300  
 97310



**Please visit our website**

**[www.hauptner-herberholz.de](http://www.hauptner-herberholz.de)**

### **Vaginal specula**

made of plexiglass, not heat-sterilisable

#### **Vaginal speculum for cattle**

350 x 40 mm

42953.000

#### **Vaginal speculum for calves and sheep**

250 x 30 mm

42954.000

#### **Vaginal speculum for mares**

420 x 50 mm

42961.040

#### **Vaginal speculum for dogs**

120 x 20 mm

42964.040

### **Vaginal specula**

made of plexiglass, with lightening,  
not heat-sterilisable

#### **Vaginal speculum for mares**

420 x 50 mm

42971.000

Replacement plexiglass-speculum

42971.040

#### **Vaginal speculum for cattle**

350 x 40 mm

42972.000

Replacement plexiglass-speculum

42972.040

#### **Vaginal speculum for calves and sheep**

250 x 30 mm

42973.000

Replacement plexiglass-speculum

42973.040

#### **Vaginal speculum for dogs**

120 x 20 mm

42974.000

Replacement plexiglass-speculum

42974.040



**Please visit our website**

**[www.hauptner-herberholz.de](http://www.hauptner-herberholz.de)**



## Vaginal specula

### **Polansky's vaginal speculum**

strong pattern, 25 cm long, branches made of tempered steel, nickel-chrome-plated

42840.000



### **Lamp carrier with nut**

in combination with light attachment 42960 for speculum 42840, nickel-chrome plated

42841.000



### **Vaginal speculum for sheep**

16 cm long, nickel-plated

43772.000



## Tubular specula

### **Prof. Dr. Götze's tube speculum**

for cows, 38 cm long, cylindrical, made of light metal, inner diameter 4 cm

42955.000



### **Prof. Dr. Abelein's tube speculum**

37 cm long, conical, made of light metal, inner diameter 4,4 - 7,5 cm

42956.000



### **Tube speculum**

nickel-plated brass, for pigs and cows, length 40 cm, cylindrical, inner diameter 2,5 cm,

42959.000



### **Tube speculum**

nickel-plated brass, cylindrical, with built-in Prof. Dr. v. Mickwitz's lamp carrier, for light attachment 42960

for pigs, 400 x 26 mm

42958.000



for calves and sheep, 300 x 28 mm

42966.000

## **Sexual organ instruments**



### **VAGOCHECK**

Vaginal mucus stick, 42 cm long.

The alternative to the vaginal specula

- very easy to use (mucus will be collected in specially shaped rubber cap)
- saves time
- effective results
- stainless

42946.000



### **Merk's swab catheter**

for taking samples from vaginal mucus of mares, stainless, 58 cm

42947.000



### **Kevorkian's uterine biopsy forceps**

54 cm, stainless

42940.000

## **Catheters**

### **Prof. Dr. Götze's cervix catheter**

4 mm Ø, Luer mount, chrome-plated



44 cm, straight

43151.500



54 cm, slightly curved head

43154.500

### **Cervix cannula with Luer mount**

37 cm, 5 mm Ø, stainless



43153.500

### **Dr. Glock's uterine catheter**

for sows, with Luer mount, 45 cm, 5 mm Ø, stainless



43155.500

### **Urinary catheter for dogs**

with Luer mount, straight, 15 cm, 3 mm Ø, nickel-plated



37111.000

## Catheters

### **Imminger's urinary catheter**

for cows, with tubing mount, stainless, 30 cm,  
5 mm Ø

36990.000



### **Urinary catheter for bitches**

with Luer mount, curved head, 2,5 mm Ø, 18 cm,  
nickel-plated

37121.000



### **Urinary catheter for bitches**

with Luer mount, curved head, 25 cm, nickel-plated  
2,5 mm Ø

37151.000



3,5 mm Ø

37152.000

### **Urinary catheter for stallions, 140 cm, plastic**

7 mm Ø

37012.000

8 mm Ø

37013.000



### **Urinary catheter for mares, 60 cm, plastic**

8,6 mm Ø

37081.000

10 mm Ø

37082.000



### **Elastic dog catheter**

with Luer mount, x-ray-able, clear, tissue friendly, single  
steril packed, for all dog breeds, 50 cm

2 mm Ø

37102.000

2,6 mm Ø

37104.000

3,3 mm Ø

37106.000



### **Elastic cat catheter**

with Luer mount, x-ray-able, clear, tissue friendly, single  
steril packed, for all cat breeds, 13 cm

1 mm Ø

37107.000

1,3 mm Ø

37108.000



### **Throat catheter**

70 cm, 4 mm Ø, Luer mount, stainless

33500.000



### **Throat spray catheter with Luer mount**

made of plastic, 70 cm, 10 mm Ø

33502.000



## Forceps



### **Cervix forceps for mares**

Prof. Dr. Götze's model, 54 cm, stainless

43217.000



### **Cervix forceps for mares**

Prof. Dr. Götze's model, 54 cm, with light attachment, stainless

43218.000



### **Glock's uterine holding forceps**

with replaceable silicone plates, 23 cm, stainless

43251.000

### **Spare silicone plates**

pair

43251.010



### **Uterine holding forceps**

with replaceable rubber plates, slightly curved, 29 cm, stainless

43252.000

### **Spare rubber plates**

pair

43252.010



### **Rumen holding forceps with hook**

straight, 20 cm, stainless

39581.000



### **Uterine pump**

with tubing, including 40 pipettes (48 cm long, Ø 1 cm)

43181.000

The uterus pump is especially created for pigs and for rinsing the uterus, particularly for treatment after infections or cleaning after birth. The liquid, which should be pumped into the uterus for rinsing, has to be poured into the pressure reservoir and it should be closed. Now build up the pressure by using the pump piston lever. Do not build up too much pressure. Now connect the free tube end with the disposable uterine catheter, which is included in the supply. Please insert the catheter carefully into the uterus and release the pressure with the hand lever. Now the uterus will be rinsed. Be careful and avoid any over-pressure or injuries to the uterus. After use please dispose of the plastic catheter. The single disposable plastic uterus catheters can be ordered from us.

## **Trocars**

### **Metal trocar**

with 2 cannulas (nickel-plated), shaft length 11 cm, 5 mm  
Ø, stainless

12930.000

### **Spare cannula, nickel-plated**

12930.150



### **Metal trocar**

with 2 cannulas (nickel-plated), shaft length 17,5 cm, 7,5  
mm Ø, stainless

13280.000

### **Spare cannula, nickel-plated**

13280.150



### **Trocar for abomasum operation**

for fixing the the abomasum on the abdominal wall with 2  
fixing sticks, shaft length 11,5 cm, 5 mm Ø

13290.000

### **Pair of fixing sticks**

strip 28,5 cm long, handle 4 cm

13290.300



### **Buff's screw trocar**

coloured plastic, shaft length 11 cm, with metal stiletto,  
for calves

13800.000

### **Trocar without stiletto**

13800.010

### **Stiletto, single**

13800.020



This rumen trocar is used for cases of acute bloating of cattle, or in cases of chronic bloating, particularly of weaned calves, because the repeated insertion of a catheter in the gullet causes irritation and inflammation of the mucus, leading to the tiresome need for watching the animal and often to slaughtering it.

Make the puncture in the left side at the bottom of the hollow in the side above the sloping line of muscle. Preferably incise the skin over a length of one or two centimeters (after a local anesthetic) to facilitate puncture of the muscle wall and of the rumen. Then insert the trocar in the direction of the joint between the shoulder and the right leg. After the puncture, withdraw the inner threaded rod and screw the cannula completely clockwise so that it holds the rumen against the peritoneum, eliminating any risk of peritonitis. If a space remains between the skin and the trocar disk, use a strip of gauze to hold the rumen on the muscle wall. To prevent obstruction of the cannula, leave the stilet in place and only remove it to allow evacuation of gas, several times a day. The cannula can be left in place for several days, or even a few weeks, without risk of losing it or causing distress to the animal. To remove the trocar, preferably incise the skin over a length of one or two centimetres and then unscrew it. The wound closes spontaneously

## **Pliable balling guns**



### **Pliable balling gun**

for feeding pills, 19 mm inner diameter, nickel-plated, not suitable for sheep

35040.000



### **Pliable balling gun**

for feeding pills, 12 mm inner diameter, nickel-plated, for sheep

35045.000



### **Pliable balling gun**

with enlarged cup, also for feeding foreign body cage magnets, 35 mm inner diameter, stainless

35060.000

## **Foreign body cage magnets**



### **„Cap Super II“ magnet**

for effective prophylaxis immediate treatment of foreign body disease of cattle

- with strong magnetic power -

39780.000



### **„VmP blue“**

for effective prophylaxis of foreign body disease of cattle

39782.000

## **Stomach tubes and probangs**



### **Neumann-Kleinpaul's stomach tube**

rubber, 2,25 m, 16 mm Ø

34480.000

### **Stomach tube for horses and cattle, plastic**

with funnel shaped ending, plastic



length 3 m, inner-Ø 15 mm, outer-Ø 19 mm

34492.000

length 2,70 m, inner-Ø 13 mm, outer-Ø 16 mm

34493.000

length 2,70 m, inner-Ø 10 mm, outer-Ø 13 mm

34494.000

length 2,10 m, inner-Ø 6 mm, outer-Ø 9,5 mm

34499.000

## Stomach tubes and probangs

### **Krüger's stomach tube**

rubber, 2,50 m, 15 mm Ø

34491.000



### **Stomach tube for foals**

rubber, 1,50 m, 11 mm Ø, with drenching end

34500.000



### **Wooden mouth gags**

for probangs

for cattle

34760.000



for calves and sheep

34770.000

### **Thiro's probang**

2 m, 17 mm Ø

34700.000



### **Stomach tube**

with extractor, the wire spiral is fitted with cup shaped and loop attachments. These are used as desired, to extract or to push down the obstruction, 1,60 m long, stainless

34920.000



### **Witte's large loop**

loop length 20 cm, only for 34920, stainless

34923.000



### **Irrigator**

complete with: container made of plastic (2 l capacity; 23711.000), plastic tubing (3 m, inside-Ø 10 mm, outside-Ø 15 mm; 24415.000), tubing clamp (24282.000), wooden cannula (31 cm long; 23950.000), wooden cannula (18 cm long; 23960.000)

23710.000



Illness or disease requiring treatment which involves large amounts of liquid often appear in horses, foals, cows, cattle, calves and sheep. For this reason our stomach tubes can be used. To avoid a biting through of these plastic or rubber tubes they are inserted through the nose into the stomach. The liquid is applied by holding one end up to use the natural fall. Furthermore these tubes can be used for letting out gas from the stomach of cattle. In this case please insert the stomach tube through the mouth into the stomach. To avoid biting through it is recommended to use some protection like a wooden mouth gag or something similar. One more possibility is to insert the stomach tube empty and to close the free end outside with any stopper or a finger when the lower end in the stomach is in good position. If you now withdraw the tube you will get a quantity of liquid to release.

**Set for taking out the ruminal juice**



**Set for taking out ruminal juice**

for taking and transmitting ruminal juice of cattle. For identification and treatment of problems of the preruminal digestion, with 1,90 m long spiral probe, with hand-operated pump 34960.400 and special suction head 34960.020, can also be used for drenching

34960.000

**Instructions**

- 1) Mount suction head on the spiral probe - mount firmly by hand -
- 2) Then mount the hose connector of the suction pump (in the back!) to the hose coupling of the spiral screw

- 3) Now introduce the suction head part with the spiral to the stomach
  - 4) Suction pump with open ball valve (the pump can only be pressed when the valve is open) press once and hold. Close the ball valve (red lever)!
  - 5) Please release the handle (vacuum will occur) and juice from the stomach will be sucked in. Maximum pumping capacity per stroke 250 ml. Open the ball valve and put the stomach juice from the pump into a suitable container. Hold the handle and close the ball valve.
- It may be necessary to repeat this procedure several times, until the maximum pumping capacity is reached. With the hose connector of the pump on the front part of the suction pump, it is also possible (by connecting a probe to the drenching set) to input liquids directly into another animal. (with usual container). Spiral with nozzle 16000.020 also usable for drenching.



**Suction pump**

hand-operated, to be connected to the spiral probe 34960, for taking out ruminal juice

34960.400



**Electric pump**

to be connected to the spiral probe 34960 for drenching liquid into the stomach, illustration see page 91

16001.010



**Suction head**

individually as spare part, for spiral probe of the set for taking out the ruminal juice, stainless

34960.020



**Spiral probe**

stainless, 1,90 m

34960.900



## Drenching kit

### **Drenching kit**

with manual pump and coil 1,25 m

16005.000

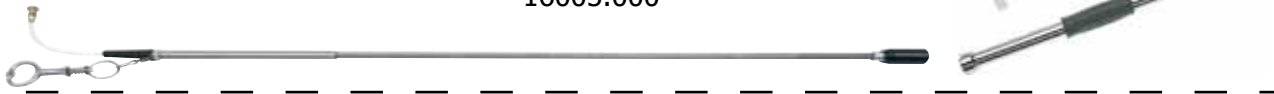

### **Drenching kit**

with coil 1,25 m and nose twitch for fixing and electric pump, tube

16001.000

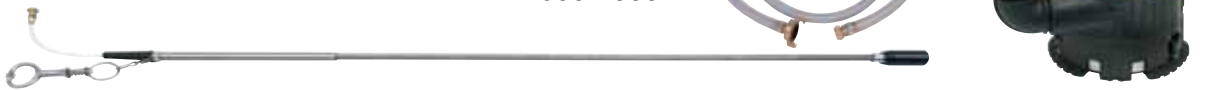

### **Drenching kit**

with manual pump and coil 1,90 m

16005.900



### **Drenching kit**

with coil 1,90 m and electric pump, tube

16009.000



### **Screwable head nozzle, single**

16000.020

### **Manual pump, single, nickel-plated**

16005.010

### **Tube, single**

16000.350

### **Coil, single, 1,25 m, stainless**

16000.500

### **Coil, single, 1,90 m, without nose twitch, stainless**

16000.900

### **Nose twitch, single, stainless**

02881.000



The drenching liquid is sucked by the pump and lead into the rumen through the tube for drenching. The well-being of the cows is enhanced by the drenching, and the dehydration of „empty“ cows (e.g. after calving) is prevented by the absorption of water. The cow gets approximately 50-80 litres handwarm water, possibly with energy carriers or mineral nutrients sucked into the rumen (But please contact your veterinarian in advance). As needed the drenching tube can also be used as coil. For this you remove the screwable head nozzle and replace it with a sharp loop 34920.230 for cutting and pulling feeding pieces out of the gullet. Or you use a cup 34920.040, for pushing the feeding pieces into the gullet. The tube can remain in the coil.

## Examination and operation tables

### **Operation and examination table type 2001**

- electrically-pneumatically adjustable in height from 45 to 105 cm by using the foot pedal
- no electricity or control in the foot pedal
- Scissors lifting principle with a maximum weight for lifting of 150 kg
- with steel plate 60 x 145 cm, on demand with additional charge with frame and drain
- with wooden underlay
- not tiltable
- smooth and with less vibrations
- totally stable and strong
- movable on one side
- easy-care and maintenance-free
- a lot of space for legs and feet
- for working in a comfortable way for the back
- modern design
- high quality



46950.000

### **Anti-slide mat**

transparent, 60 x 150 cm

46950.010



### **Instrument table**

80 cm high, with 2 trays, chrome-nickel steel plate  
70 x 60 cm

46963.000

60 x 45 cm

46964.000



### **Mayo stand**

with wall protection, adjustable in height 90-132 cm,  
60 x 40 cm, electrically conductive, stainless

46970.000

## **Examination and surgical lamps**

### **Examination lamp - floor model -**

for diagnosis and small surgery, with energy-saving LEDs, latest technology, focusable, light intensity 40.000 Lux in 1 meter distance,  
 colour reproduction RA = 95  
 Kelvin 4.500  
 light field diameter 14-25 cm  
 number of LEDs = 12  
 power consumption: 18 watt  
 On/Off-switch and brightness control at the lamp's head  
 with swing-4-foot-stand, short arm joint and including power supply at the handle

47267.000

### **Examination lamp - wall model -**

for diagnosis and small surgery, with energy-saving LEDs, latest technology, focusable, light intensity 40.000 Lux in 1 meter distance,  
 colour reproduction RA = 95  
 Kelvin 4.500  
 light field diameter 14-25 cm  
 number of LEDs = 12  
 power consumption: 18 watt  
 On/Off-switch and brightness control at the lamp's head  
 with swing wall-arm, including power supply

47267.500

### **Examination lamp - ceiling model -**

for diagnosis and small surgery, with energy-saving LEDs, latest technology, focusable, light intensity 40.000 Lux in 1 meter distance,  
 colour reproduction RA = 95  
 Kelvin 4.500  
 light field diameter 14-25 cm  
 number of LEDs = 12  
 power consumption: 18 watt  
 On/Off-switch and brightness control at the lamp's head  
 with swing ceiling-arm, including power supply, for a room height up to 3 meter

**Please indicate your room and fastening height!**

47267.600

### **Operating lamp**

for minor and middle surgery, stand model with five feet antistatic castors, head movable in all directions (100-250 cm height), natural colour reproduction, high light intensity 50.000 Lux, shadowless illumination, heat absorbing filter, 3 Halogen bulbs 24 V / 40 W, illumination field 20 cm, mains supply 230/240 V

47263.000

### **Spare bulb**

Halogen, 24 V / 40 W

47263.110

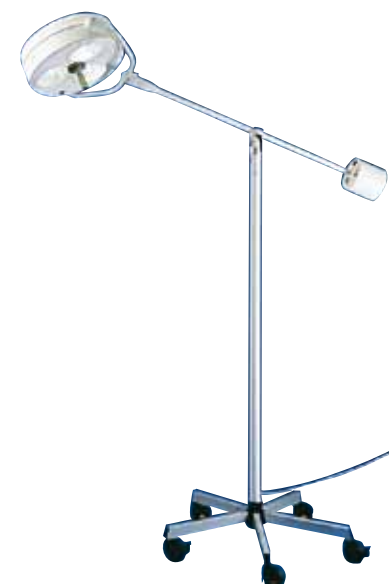

## Trays and dishes



### **Instrument tray**

for all OP-tables, 23,5 x 19 x 4 cm,  
stainless

46947.070



### **Kidney dish**

flat, without lid  
17 cm  
25 cm

**SLine** 97916  
**SLine** 97917



### **Tray for veterinary instruments and bandage**

23,5 x 19 x 4 cm **SLine** 97900  
33 x 23 x 3 cm **SLine** 97901  
33 x 23 x 5 cm **SLine** 97902



### **Instrument container**

stainless  
20 x 10 x 3,5 cm

24900.000

23 x 13 x 5,0 cm

24901.000



### **Instrument container with lid**

22 x 15 x 5 cm **SLine** 97923  
26 x 15 x 5 cm **SLine** 97924  
30 x 18 x 5 cm **SLine** 97925



### **Plastic service**

with stowable grip, 55 x 17 x 15 cm

26100.000

**Please visit our website**

**[www.hauptner-herberholz.de](http://www.hauptner-herberholz.de)**

## Oven and centrifuge

### **Universal ovens for sterilising, drying and incubating**

electric hot air system with wide range of applications from 30 up to 220°C, with timer 0 - 2 hours, cabinet switches off automatically at the end of the set period.

14 l stainless steel interior, 1 perforated stainless steel shelf, exterior dimensions without door handle 47 x 52 x 32,5 cm  
interior dimensions 32 x 24 x 17,5 cm,  
230 V electrical supply

46810.000

39 l stainless steel interior, 2 perforated stainless steel shelves, exterior dimensions without door handle 63 x 60 x 40 cm  
interior dimensions 48 x 32 x 25 cm,  
230 V electrical supply

46830.000

### **Autoclave, standard model**

compact and proven construction according to German security norms, temperature 120°C/1 bar, the unit takes 5 trays, 19 litre, 45 x Ø 23 cm

46718.000

### **Tray**

46718.010

### **Sterilising containers for autoclave**

39,5 x 14 x 8,5 cm

46717.100

39,5 x 14 x 4,0 cm

46717.110

18,5 x 14 x 4,0 cm

46717.120

Ø 11 x 10 cm

46717.130

### **Laboratory centrifuge**

for surgery and laboratory, with impact-proof and break-proof plastic body, centrifuge for 8x 15 ml, barrels made of fiber-glass reinforced polyamide, autoclavable, electronic cover blocking, continuous rotation speed regulation with display, max. rotation speed 5.500 r/min = RZB 2875, with timer up to 60 min., 230 V, dimensions 200 x 245 x 280 mm

50155.000



**For further offers of universal ovens and autoclaves please contact us!**



## **Bandages**

### **Surgical cotton**

10 cm x 3 m

42800.000



### **Surgical gauze**

8 cm x 5 m

42805.000

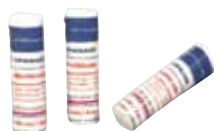

### **Gauze bandage**

separately packed, 10 cm x 4 m

42811.000



### **Elastic bandage**

separately packed, 10 cm x 4 m

42816.000



### **Gauze bandage**

10 cm x 4 m, box of 20 pieces

96411.000



### **Elastic bandage**

10 cm x 4 m, box of 20 pieces

96416.000



### **Co-Flex-bandages**

cohesive, flexible, high quality, strong, comfortable, lightweight and quick bandage, wraps easily, adheres only to itself

length: 4,5 m stretched out

colour: white

7,5 cm wide

42822.000

10 cm wide

42824.000

**Please visit our website**

**[www.hauptner-herberholz.de](http://www.hauptner-herberholz.de)**

## Accessories

### Plastic collars

simply fasten to regular collar

neck-girth 22 - 26 cm, collar width 7,5 cm	33007.000
neck-girth 22 - 26 cm, collar width 10 cm	33010.000
neck-girth 26 - 35 cm, collar width 15 cm	33015.000
neck-girth 35 - 44 cm, collar width 20 cm	33020.000
neck-girth 44 - 53 cm, collar width 25 cm	33025.000
neck-girth 53 - 63 cm, collar width 30 cm	33030.000



### Disposable gloves

with 5 fingers, sensitive, 85 cm long, pack of 100 pieces  
47511.000



### Disposable gloves (insemination gloves)

with 5 fingers, sensitive, shoulder-length, 100 pieces in one box  
47517.000

### Disposable protection boots

with laces, 0,06 mm thick, 43 cm high, clear, pack of 50 pieces  
47516.000



### Examination gloves

of natural rubber latex, not powdered, non sterile, pack of 100 pieces  
medium  
47502.000

large  
47503.000



### PP-Overall

white with hood, through-going zipper, elastic band at arms and trousers legs, waistline elasticated

XL	47604.000
XXL	47605.000



## **Bull rings**

- ✓ superior quality and manufacturing
- ✓ individually controlled
- ✓ safety lock-system
- ✓ all bull rings complete with stainless safety screw and spanner
- ✓ minimum quantity **6 pieces**



### **Flessa-bull rings**

stainless steel, inner-Ø 52 mm

05762.000

stainless steel, inner-Ø 61 mm

05772.000



### **Flessa-applicators**

matt nickel-plated, for Flessa-bull rings, inner-Ø 52 mm

05740.000

black, for Flessa-bull rings, inner-Ø 61 mm

05770.000



### **Bull rings**

made of polished steel, inner-Ø 57 mm

05801.000

made of stainless steel, inner-Ø 57 mm

05802.000

made of polished steel, inner-Ø 65 mm

05811.000

made of stainless steel, inner-Ø 65 mm

05812.000



### **Applicator**

for bull rings with inner-Ø 57 mm

05800.000

for bull rings with inner-Ø 65 mm

05810.000

### **Spare safety screw**

stainless

05802.040

### **Spare spanner**

05761.050



### **Strub's ring for crib biters**

for cattle, for application with 03821 into the tongue and it avoids the crib biting, nickel.plated

03820.000



### **Forceps for ring**

for the application or removing of 03820, 24 cm, nickel-plated

03821.000



## **Bull leaders**

- ✓ strongly constructed
- ✓ with strong steel tubing with metal slide

### **Bull leader**

1,45 m long

05980.000

1,20 m long

05981.000

1,45 m long, with open handle

05970.000



## **Pig nose rings**

- ✓ high quality
- ✓ hinge and lock are milled and deburred
- ✓ individually controlled, no bulk good
- ✓ packed 50 pieces in a box
- ✓ minimum quantity **10 pieces**

### **Pig nose ring**

against the digging of pigs, self-piercing through the nasal cartilage and self-locking, 40 mm Ø

69440.000



### **Applicator**

for inserting pig nose rings, strong model, forged steel

69441.000



## **Pig snout rings**

**Minimum quantity 100 pieces of each size**

### **Pig snout ring**

small, 2,4 x 31 mm

69381.000

large, 2,4 x 35 mm

69382.000

extra large, 2,4 x 40 mm

69385.000



### **Applicator**

for inserting pig snout rings

22125.000



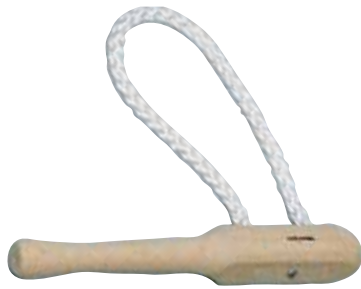

## Nose holders for horses

### **Wooden nose twitch**

with strong rope, 21 cm

02800.000

## Nose holders for cattle



### **Nose holder**

with spring, ca. 14 cm, stainless

02881.000



### **Nose holder**

with rolling adjuster, strong model, forged steel,  
ca. 20 cm, nickel-plated

02980.000



### **Holding forceps**

for holding the head, forged steel, with plastic coated  
handles, 33 cm

02985.000



### **Eisenhut's nose holder**

easy to use because of the long handles, ca. 44 cm

02970.000



### **Harms' nose holder**

with slide adjuster, simple model, stainless ca. 19 cm

02983.000



### **Nose holder**

made of stainless steel, ca. 19 cm, designed to use with a  
rope 2,5 m long, 8 mm Ø (inclusive)

02984.000

## Mouth gags

### **Mouth gags**

Mouth gags can be used for dental treatments, feeding of drugs and general examinations and surgery. It is helpful to open and fix the mouth of the animal, to make examinations or operations without any difficulties. With the mouth gags you have a better overview in the mouth and it is easier to feed drugs, because the animal cannot close the mouth.

### **Schulze's mouth gag**

for horses and cattle, 35 cm, nickel-plated

03110.000



### **Günther's mouth gag**

for anaesthetised horses, inner width 17,5 cm, inner height max. 11 cm, nickel-chrome-plated

03190.000

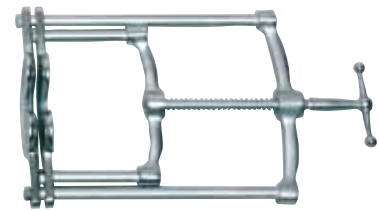

### **Schoupé's mouth gag**

for horses, 27 cm, stainless

03111.000



### **Climax-Hausmann's mouth gag**

for horses, with nylon stripes

03112.000



### **Bayer's wedge**

for horses and cattle, max. height 7 cm, nickel-plated

03690.000



## Mouth gags



### **Mouth gag**

for dogs, distance approx. 8,5 cm, stainless

03660.000

### **Mouth gag**

for dogs, distance approx. 14,5 cm, stainless

03661.000

For examinations and treatments in the mouth and head areas of small animals like cats and dogs, we supply a line of mouth gags in different sizes. The mouth gags consist of 2 lever arms and one main bar with spring. The lower arm is firmly fixed with the bar and the upper arm is gliding freely on the spring-covered bar. Before placing the mouth gag into the dog's mouth, push the free upper lever downwards so that the spring is getting tension. Now you can place the unit into the mouth. The end of each arm is fitted with a piece of rubber that has a central hole for the canine teeth. This protects the teeth as well. The moment you release the upper lever of the mouth gag the jaws of the dog will be spread by the pressure of the spring. Because of the natural counter pressure of the dog the upper lever aligns itself on the lower bar. In this moment it is fixed and the dog can not bite. You have a perfect free space for dental or pharynx examinations or operations.



### **Mouth gag**

for cats, distance approx. 6 cm, stainless

03662.000



### **Cheek spreader**

for rabbits, stainless

5,5 cm

03670.000

8 cm

03671.000

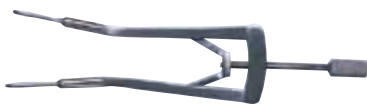

### **Jaw spreader**

for rabbits, 13 cm, stainless

03673.000



### **Jaw spreader**

for rabbits, 12 cm, stainless, strong model

03674.000

**Please visit our website**

**[www.hauptner-herberholz.de](http://www.hauptner-herberholz.de)**

## Restraining instruments

### **Bron's clamp**

for a reliable and painless immobilisation because of captivation of the hind legs, no damage of skin or tissue, for safe and challenge free working - recommended for claw treatment -

(not usable for very large and heavy animals)

04858.000



### **Anti-kick bar**

made of steel tubing, for different animal height, nickel-plated, 8 times adjustable

04900.000



### **Spare spring**

single

04900.019

### **Spare rubber**

single

04900.040

### **Lifting device for cows**

an essential tool for erecting cows for example after difficult births.

The rubber coated handle bracket is adjustable for every size of an animal. This can be fixed with the ring on the joint, which allows the erecting of the cow with the help of a block and tackle.

04845.000



### **Spare parts**

Threaded bolt with screw

04845.010

Bolt without thread

04845.020

Distance tube

04845.030

Handle

04845.050

Star handle

04845.060

Screw nut for handle

04845.070

Bar separately

04845.080

### **Berlin casting hobble**

also for smaller horses, consisting of: 1 main hobble and 3 hobbles, 3 m strong rope, 1,25 m chain (black powder-coated) and spring hooks

03910.000

### **Spare hobble**

for casting hobbles 03910, single

03930.000



## Restraining instruments

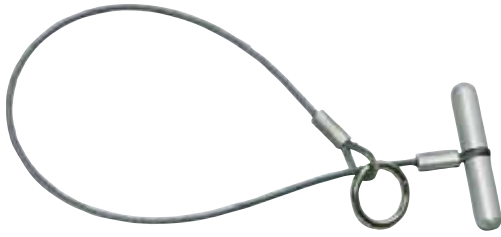

### **Wire nose pig holder**

wire rope, with a high tensile strength, guarantees a safe holding of the animal, loop diameter ca. 22 cm

04980.000



### **Pig holder**

wire rope (lack powder-coated), strong wire, with a high tensile strength, tubing length 60 cm, loop diameter ca. 22 cm

04990.000

### **Spare wire**

without handle

04990.230

### **Spare wire**

with handle

04990.240



### **Dog catcher**

made of steel (nickel-plated), strong wire, tubing length 150 cm, loop diameter ca. 30 cm - At your request dog catchers can be made in any required length -

04990.980

For catching the animal, it is necessary to grab the black front handle in both hands. Afterwards you can put the loop over the head of the animal and fasten it with the adjustable back handle. This should be held tightly, then it is possible to lead the animal without any difficulty.



### **Sheep catching hook**

made of anodised light metal, very stable, anti-slip plastic handle, the hook is an ideal size for neck and leg catching, ca. 1,25 m

04970.000



### **Tension line**

for tying up rear limb, ca. 9 m long, 5 cm wide, made of polyester, tractive power 2.000 kg

04810.000



### **Sorting panel**

for pigs, 2-way sorting panel, made of polyethylene, rounded hand grips on top and side to use two ways, lightweight, 76 x 94 cm

99601.000



### **Sorting paddle**

for pigs, made of polyethylene, 94 cm long

99602.000

## Electric animal goads and extension handles

### **Electric cattle coaxer „Hotschock“**

without electronic cut off, without batteries

06092.000



### **Electric cattle coaxer „Hotschock“**

with automatic cut off after 2 sec., without batteries

06092.200



### **„KAWE“-Electric animal goad**

without batteries, also available with 2-sec.-impulse

06094.000



### **Battery**

for all electric animal goads (2 pieces required)

06091.210

### **Extension handle**

made of robust plastic, 70 cm long

06094.500



### **Electric animal goad**

made of strong plastic, ergonomic shape, with plastic cover, improved battery holding, without batteries

06095.020



### **Electric animal goad**

as 06095.020 + automatic switch off after 2 seconds

06097.020

### **Battery**

for electric animal goad 06095.020 and 06097.020  
(2 pieces required)

06095.010

### **Extension handle**

for 06095.020 and 06097.020, 65 cm long

06096.000



During the loading of animals into the cattle carrier or during the moving of animals inside the stable, often there is a certain resistance of the animals and they do not want to move anymore. In such a situation our electric animal goad is very helpful. The electric animal goad produces a small electric shock, which is unpleasant for the animal, but it is not hurtful. The electric animal goad has two springy pins, which are pushed into the electric animal goad, if you press it on the animal. Through this the electric circuit is closed. The batteries, which are in the Electric animal goad produces then with a small convertor a little impulse. This impulse effects that the animal will jump up or will continue moving. The electric animal goad is suitable for cattle, cows, calves and pigs.

It is very important that the pins of the electric animal goad are always clean. Because the fat of the skin can easily stay on the pins and comes off the pins into the plastic cover and this can lead to damage. If there are situations, in which for example more animals have to be moved, it is possible not to reach every animal although you use your outstretched arm. In this case it is very helpful to use our extension handles. The electric animal goad should be put into the cap of the extension handle and with this you can reach more distant animals.

## **Serra-emasculator**

- ✓ best quality and manufacturing
- ✓ made of durable high quality steel with nickel- and chromium plating
- ✓ each Serra-emasculator is individually controlled and set regarding cutting and squeezing to minimise the risk of haemorrhage

### **Serra-emasculator**

ca. 36 cm, the emasculator avoids the sliding of the cord and the sperm cord is caught, enables holding, squeezing and cutting in one movement, the danger of haemorrhage is reduced to a minimum

38320.000

### **Spare parts**

cutting piece	38320.070
screw for the large bow 8,0	38320.140
screw for blade	38320.150
small bow 8,0	38320.060
nut	38320.270
wing screw	38000.090
spring for ratchet	38000.080
ratchet with pin	38000.200
tension screw with pin 8,0	38320.300
squeezing part with pin 8,0	38320.320
large bow complete 8,0	38320.330

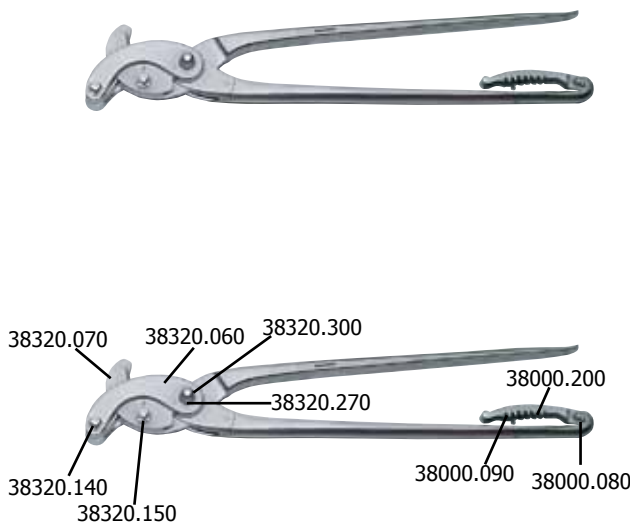

**Please note, that every repair or replacement of spare parts made on your own is a certain risk, because in general an individual adjustment to the emasculator is necessary.**



### **Serra-emasculator**

modified with curved handles for castration of the standing stallion, without ratchet, ca. 35 cm

38321.000

### **Advice for disinfection of the Serra emasculator**

New instruments have to be cleaned prior to the first use or first sterilisation. Protection caps or folios have to be completely removed if any. Emasculators have to be dismantled after using them with the attached wrenches. Shanks and head have to be dismantled into single parts. Attention please: Notice the correct way in which to assemble and follow this method. All screws have to be hand-tight. Our emasculators can be sterilised with hot air or autoclave. They are made of rigid carbon steel with nickel-chromium-plating. Leave in disinfecting liquid for a maximum of 15 minutes, rinse it and dry it well. Please follow the manufacturer's user instructions on whichever steriliser you choose to use. All other instruments in the sterilizers must be clean and there should be no trace of dirt in the sterilisation chamber because corrosion can be transferred to other instruments. After use contaminated instruments should be prepared for sterilisation as soon as possible. In case of mechanised cleaning avoid cleaning shadows. Instruments which come apart must be taken apart and placed into the chamber individually. If there is any dried dirt like blood etc. clean it with Ultrasound-cleaner according to the manual of the manufacturer.

Important: Store it in dry and clean conditions. Do not store in stables. All instruments have to be well dried after sterilisation.

Some Vaseline for the joints can be used. Put just some parafin-oil on to the joints prior to next use, in case of the Serras put it on to the central screw joint so that it can be moved easily.



## Castration instruments

Our castrators are made of durable high-quality steel with nickel- and chromium plating.

### **Emasculator Masch's model**

produces a double squeezing, ca. 32 cm

38000.000



### **Spare parts**

screw / head clamping

38000.040

center bolt

38000.050

spring for ratchet

38000.080

wing screw

38000.090

ratchet with pin

38000.200



### **Reimers' emasculator**

enables the operator to cut and squeeze, 30 cm

38030.000



### **Spare parts**

center bolt

38000.050

tension screw with pin

38030.200

spring for ratchet

38000.080

wing screw

38000.090

washer with square hole

38030.100

spring (leaf)

38030.130

nut

38320.270

ratchet with pin

38000.200

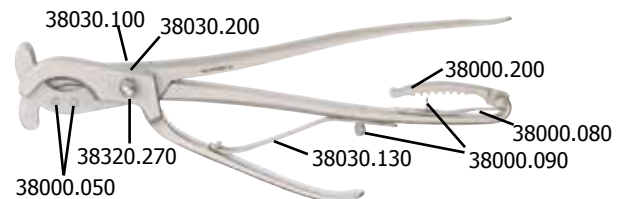

### **Emasculator Hausmann's model**

for heavy horses, 36 cm long, nickel-chrome-plated

38210.000



### **Emasculator Hausmann's model**

for piglets, also suitable for docking of piglets, 19 cm long, nickel-chrome-plated

38220.000



### **Emasculator Hausmann's model**

for horses and boars, also suitable for castration or docking of lambs, 27 cm long, nickel-chrome-plated

38230.000

**Castration instruments**



**Castrator model „Burdizzo“**

Castrator for a bloodless castration, with cord stop, which avoids the sliding of the cord, large model for bulls, 8 cm jaw, 48 cm long, nickel-plated, standard-quality with knee bracket

38590.000

profi-quality, without knee bracket

38591.450

knee bracket, single

38590.020



**Castrator model „Burdizzo“**

Profi-quality, small model for rams, 30 cm long, jaw 4,5 cm, nickel-plated

38600.000

standard-quality, for rams, 35 cm long, nickel-plated

38610.000

standard-quality, for lambs, 23 cm long, nickel-plated

38620.000

profi-quality, for lambs, 23 cm long, nickel-plated

38621.000



**Castration hook**

for cats, 14,5 cm long, bow 7 mm, stainless

38661.000



**Docking and sterilisation equipment**

**Electric equipment for docking tails of piglets**

with power supply, built-in illumination and one special burn-cutter, 230 V, 70 W

Docking and sterilisation can be made in one step, this avoids infections, according to VDE instructions

28170.000



**Docking and sterilisation equipment**

gas-operated, to be refilled with lighter gas, complete with one unit of lighter gas

28175.000

**Knife part, single**

28175.010



**Special stretching forceps**

for rubber rings 33370, 21,5 cm long, nickel-plated

33371.000

**Special rubber rings**

for docking tails of piglets and lambs, pack of 100 pieces

33370.000



## Dehorning instruments

### **Dehorning shears**

with one pair of spare blades, 106 cm, opening for horn  
9 cm wide, 7,5 cm long, stainless

33350.000

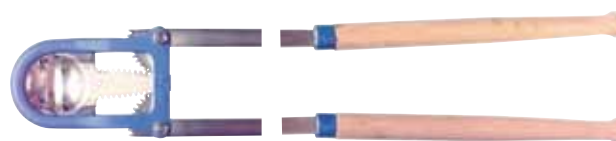

### **Dehorning shears**

same as 33350 but only 76 cm long

33350.950

### **Spare blades**

for dehorning shears, pair, nickel-plated

33351.000



### **Prof. Dr. Götze's hand grip for wire saw**

open handle, stainless

46061.000



### **Prof. Dr. Götze's hand grip for wire saw**

barrel shaped, nickel-plated

46060.000



### **Special wire saw for dehorning**

10,80 m long

46140.000

3,60 m long

46141.000

100 m long

46142.000

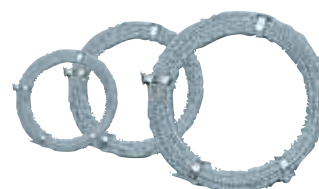

### **Caustic stick**

for the dehorning of calves aged 1 - 4 weeks, several  
animals can be treated with one stick

33380.000



### **Electric dehorner**

for calves and fallow deers aged 4 - 6 weeks, with 1 tip  
(17 mm Ø), 4 m cable between transformator and  
burn-cutter, double insulated, heating element 24 volt /  
200 watt, transformer 230 volt

- secure, fast and bloodless dehorning in 10 seconds
- with VDE transformer 24 volt / 200 watt
- according to VDE instructions
- double insulated
- with holder for the burn cutter

33438.000



### **Transformer with holder**

33438.150

### **Electric dehorner without transformer**

33438.200 / 33438.250

### **CEE plug**

33438.260

### **Spare dehorner tip, single, 17 mm Ø**

33438.010

### **Heating element**

24 V / 200 W for electric dehorner 33438

33438.180

### **Heating element**

for the old model of electric dehorner 33435, 24 V

33435.020

## Hoof knives

Manual work with the following quality control guarantees a good product!

- ✓ guarantees an optimal grip and load transmission because of an ergonomic shaped wooden handle
- ✓ we use only high-quality german steel
- ✓ long lasting cutting output
- ✓ accurate manufacturing
- ✓ strict quality control during the whole manufacturing process
- ✓ excellent product reliability because of decades of experience and the optimal proportion of hardness / flexibility and the material viscosity
- ✓ optimal price performance ratio



### **Hoof knife, 65 mm cutting length**

right, with white wooden handle

40590.000



left, with white wooden handle

40591.000



### **Hoof knife, 65 mm cutting length**

right, with brown wooden handle and wide blade

40602.000



left, with brown wooden handle and wide blade

40603.000



### **Hoof knife, 55 mm cutting length**

right, with brown wooden handle for small horses and ponys

40605.000



left, with brown wooden handle for small horses and ponys

40606.000



### **Hoof knife, 70 mm cutting length**

right, with curved blade, for cattle, stainless

40625.000



left, with curved blade, for cattle, stainless

40626.000



### **Hoof knife, 65 mm cutting length**

right, with black wooden handle and thin blade, nickel-plated

40641.000



left, with black wooden handle and thin blade, nickel-plated

40642.000

## Hoof knives

### **Hoof knife, 55 mm cutting length**

right, with brown wooden handle and thin blade, for exact cut-out

40647.000

left, with brown wooden handle and thin blade, for exact cut-out

40648.000



### **Hoof knife, 70 mm cutting length**

right, with brown wooden handle and wide blade with double cutting edge

40671.000

left, with brown wooden handle and wide blade with double cutting edge

40672.000



### **Hoof knife, 70 mm cutting length**

right, with ergonomic wooden handle, stainless

40620.000

left, with ergonomic wooden handle, stainless

40621.000



### **Hoof knife, 55 mm cutting length**

Hauptner Professional, right, with brown and hand shape adapted wooden handle, this allows very safe working, thin blade

40607.000

Hauptner Professional, left, with brown and hand shape adapted wooden handle, this allows very safe working, thin blade

40608.000



### **Hoof knife, 55 mm cutting length**

right, crescent-shaped

40622.000

left, crescent-shaped

40623.000



## Hoof and claw instruments



**Claw knife swiss pattern**  
with wooden handle, 18 cm

40705.000



**Shepherd knife**  
with 2 blades, 45 and 30 mm long, exotic woods  
- a knife, indispensable for shepherd and farmers -

40710.000



**Hoof knife**  
for sheep, curved blade, stainless, with hardwood handle,  
55 mm

40711.000



**Hoof knife**  
for sheep, with blade made of cast steel, foldable, with  
hardwood handle, polished, solid model, 50 mm long  
- The advantage in comparison with a stainless blade is,  
that it stays sharp for longer and it is easier to sharpen -

40712.000



**Hoof knife set**  
in leather case, with 5 interchangeable blades, 1 sage  
knife, 2 drawing knives, 1 searcher, 1 hoof knife left,  
with spring fastening  
- all blades are nickel-plated -

41280.000



**Quittor knife**  
all metal, 18 cm, stainless

41480.000



**Frick's sharp curette**  
20 cm, stainless

12050.000

## For easy sharpening of hoof knives



**Sharpening stone**  
15 cm, 3,7 cm wide, Ø 0,1 - 0,7 cm, simple model

41080.000

15 cm, 3,7 cm wide, Ø 0,1 - 0,7 cm, superior quality

41081.000



**SWISS Sharpener**  
for all knives, scissors, etc.

49035.000

## Claw trimming

### **Hoof scraper**

sharpened, 30 x 3 cm

40831.000



### **Hoof scraper**

with plastic coated handle, sharpened, 28 cm

40834.000



### **Clinch cutter**

15 cm

42447.000



## Buffers

### **Buffer**

one-sided, 95 mm

42440.000



double-sided, 135 mm

42441.000



## Hoof rasps

### **Hoof rasp**

straight, with coarse and fine surface, usable on both sides, 4 cm wide, 35 cm long, thickness approx.: 9 mm

42512.000



### **Hoof rasp**

S-shaped, with coarse and fine surface, 30 cm long, 2,5 cm wide

42794.000



### **Hoof rasp**

with handle made of plastic, coarse surface, hand made, 4 cm wide, operating length: 30 cm, thickness approx.: 6,5 mm

42516.000



with wooden handle, coarse surface, hand made, 4 cm wide, operating length: 20 cm, thickness approx.: 6,5 mm

42517.000



### **Farrier's set**

in case, containing: Hoof hammer 42371, Buffer 42440, Farrier's forceps 42461, Hoof rasp 42512, Hoof knife 40605, Hoof scraper 40831

42530.000



## Hoof and claw instruments



### **Hoof tester**

with straight shanks, jaw 15 cm, 37 cm, stainless

40450.000



### **Hoof tester „model vienna“**

jaw ca. 20 cm, 40 cm, stainless

40470.000



### **Wooden hoof hammer**

made of hardwood, 8 cm Ø, 29 cm

40841.000



### **Hoof hammer**

30 cm

42371.000



### **Hoof scratch brush**

made of plastic, with plastic bristles, 17 cm

68104.000



### **Hoof shoe**

for horses, made of hard-wearing and durable plastic (Polyurethan), black, can be used several times  
- all shoes complete with lace and bandage -  
130 x 130 mm, for medium horses

42743.500

145 x 145 mm, for large horses

42746.500

160 x 155 mm, for very large horses

42748.000

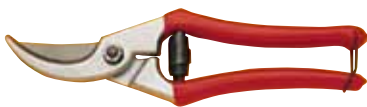

### **Claw cutter**

for sheep, forged, curved, with plastic coated handles, 23 cm

42600.000



### **Claw cutter**

for sheep, straight, pointed, 25 cm

42611.000



### **Claw cutter**

strong model, with wooden handles, 70 cm

42625.000



## Hoof and claw instruments

### **Claw and hoof cutter**

with multiple action and interchangeable blades, 42 cm  
42683.000

### **Spare blades, pair**

42683.092

### **Spare screw**

42683.100

### **Farrier nipper**

30 cm  
42461.000

### **Combination shoe puller-spreader**

with button shaped endings of the handles for a better differentiation  
- the outer grooves of the head of the plier are for spreading the horse shoe - the plier can also be used for cutting nails, forged, 35,5 cm long  
42465.000

### **Crease nail puller**

- an essential tool for the removal of misdriven nails from new shoes - forged, 30,5 cm long  
42467.000

### **Saddle horse clincher**

for use on larger nails in saddle horse hooves, 30 cm long  
42486.000

### **Farrier nipper**

for the removal of edges, forged, 38 cm long  
42680.000



**Please visit our website**

**[www.hauptner-herberholz.de](http://www.hauptner-herberholz.de)**

## Hoof and claw instruments



### **Claw cutting disk**

for claw treatment with 3 holes and hard metal (Tungsten), strong pattern, suitable for all electric grinders, medium corn, 115 mm Ø

42784.000



### **Insulate tape**

on tissue base, double adhesive, for hoof treatment

42796.000



### **Beech tree tar**

1 kg

42567.000

**For bandages and material for dressings see page 96!**

### **Hoof and claw treatment**

Because of the lack of hoof and claw treatments, there can be serious diseases. This can be seen through a general worsening of the general state of health of the animal. In many cases, the veterinarian has to perform a surgical intervention to avoid any further unhealthy consequences. Furthermore, the health of the animal has to be reconditioned as to does the performance of the animal. With the instruments of the previous pages, the normal hoof and claw treatment can be realised. It is important to shorten hooves and claws, which have grown too long. Otherwise there can be damage caused to the musculoskeletal system of the animal.

**Please visit our website**

**[www.hauptner-herberholz.de](http://www.hauptner-herberholz.de)**

## Teat instruments

### **Fürstenberg's milk tube**

with round head and side openings, 9 cm long,  
nickel-plated  
2 mm Ø

35650.000

2,5 mm Ø

35651.000

3 mm Ø

35652.000



### **Fürstenberg's milk tube**

with round head and side openings, 9 cm long,  
nickel-plated, Luer mount  
2 mm Ø

35655.000

2,5 mm Ø

35656.000

3 mm Ø

35657.000



### **Kaiser's milk tube**

with central and 5 side openings, 8,5 cm long,  
2,5 mm Ø, chrome-plated

35660.000



### **Bartel's teat cannulas**

2,5 mm Ø, 6 cm long, chrome-plated

35690.000

2,5 mm Ø, 8 cm long, chrome-plated

35691.000



### **Teat slitter „swiss model“**

9,5 cm long, 4 mm Ø, chrome-plated, blades stainless

35800.000



### **Hug's teat slitter**

12,5 cm long, 4 mm Ø, chrome-plated, stainless

35820.000



### **Hug's teat lancet**

12 cm long, 2,5 mm Ø, stainless

35830.000



### **Schecker's teat dilator**

11,5 cm long, stainless

35840.000



### **Teat slitter „danish model“**

with screw and 2 blades, 19 cm long, 3 mm Ø, nickel-plated

36080.000



## Teat instruments



### **Teat knife „french model“**

6,5 cm long, stainless

35880.000



### **Ullner's teat curette**

17 cm long, stainless

36090.000



### **Needle for udder infusion**

probe ended, 130 mm long, 1,8 mm Ø, stainless

17181.000



### **Needle for udder injection**

pointed, 130 mm long, 1,8 mm Ø, stainless

17182.000



### **Wool teat plugs**

with twisted shaft at the ending and vaseline as anti-blocking agent, shaft length ca. 4,5 cm, extendable to 8 cm, box of 20 plugs with vaseline

35750.000



### **Wool teat plugs**

with perl at one end and separated filled vaseline shelf, shaft length 5 cm, box of 20 plugs in vaseline

35751.000



### **Wool teat plugs**

made of cat gut, 4,5 cm long (extensable to 8 cm), ca. 2,5 mm Ø, box of 20 plugs with vaseline

35760.000



### **Plastic teat cannula**

with plug and side openings, through which filled salve can loosen slowly, 5 mm Ø

7 cm long, box of 10 pieces in vaseline

35770.000

5 cm long, box of 10 pieces in vaseline

35771.000

## Dental instruments

### **Blade**

17,5 cm, stainless

03676.000



### **Tooth scaler**

hawk's beak, board, 15 cm

 97480.020

32350.020



### **Tooth scaler**

hawk's beak, fine, 15,5 cm

 97480.040

32350.040



### **Tooth scaler**

wing shaped, left, 15,5 cm

 97480.330

32350.330



### **Tooth scaler**

wing shaped, right, 15,5 cm

 97480.340

32350.340



### **Tooth scaler**

double-sided, wing shaped left/right, 17,5 cm

 97480.500

32350.500



### **Lewis' tooth rasp**

for small rodents, 18 cm, stainless

03680.000



### **Dental forceps**

curved point, rifled, 15 cm, stainless

 97048

32085.000



### **Bein's root elevator**

with recessed grip, 14 cm long, stainless

5 mm  97470

3 mm  97471

2 mm  97472



## Descaler forceps

### **Dietrich's descaler forceps**

11 cm, for small dogs and cats, stainless steel

 97481

32340.000



### **Dietrich's descaler forceps**

16 cm, stainless steel

 97482

32345.000



**Dental forceps**

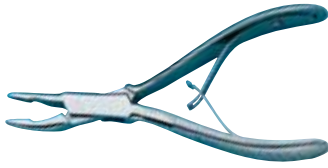

**Friedmann's dental forceps**  
12 cm, for rodents, stainless

**SLine** 97450



**Dental forceps**  
17 cm, straight, stainless

**SLine** 97451

31510.000



**Dental forceps**  
17 cm, curved, stainless

**SLine** 97452

31520.000



**Dental forceps**  
14 cm, straight, stainless

**SLine** 97453

31530.000



**Dental forceps**  
11 cm, ca. 45° curved, stainless

**SLine** 97454

31531.000



**Dental forceps**  
11 cm, slightly curved, stainless

**SLine** 97455

31532.000



**Dental forceps**  
16,5 cm, curved, for upper jaw, stainless

**SLine** 97456

31540.000



**Dental forceps**  
16,5 cm, curved, for lower jaw, stainless

**SLine** 97457

31541.000



**Dental forceps**  
for extracting wolf tooth for horses, 30 cm,  
stainless

31600.000



**Piglet tooth plier**  
also suitable as nail cutter for small animals, 13 cm,  
chrome-plated

31950.000

## **Electric tooth grinder**

### **The new piglet tooth grinder**

stronger, faster, compact design!

- strong battery pack, 18 volt, lasting for 2.5 hours (idle running)
- 20.000 rotations per minute
- portable battery pack
- handpiece only 2,75 cm diameter and 250 g weight
- Recharges in 3 hours
- complete with grinding pin, protector and bag with belt delivered with carry case

32055.000



## **Tooth rasp**

### **Tooth rasp**

65 cm long, arched, made of carbide metal, including rasp section, half-round 25 x 115 mm

32125.000



### **Rasp section**

half-round 25 x 115 mm, equipped with carbide metal, for tooth rasp 32125

32126.000



### **Tooth rasp**

The teeth of horses continue to grow even when they are very old. This affects the natural abrasion due to eating, chewing and grinding taking much longer. This effect is balanced by the fact that tooth substance is growing again.

If one tooth of the lower jaw has to be extracted because of inflammation, the facing tooth of the upper jaw is growing more than the other teeth around. This results in this tooth being higher than the others. The horse is still able to eat, but grinding is impossible. The consequence of this is that the food is not being chewed properly and as a result the stomach and the flora of the intestine are damaged. In this case it is necessary to rasp the teeth to bring them all to the same height.

## Electric 2000 PLUS - Cattle clipper -



### **NEW:**

- ✓ best silent running (approx. 75 dB)
- ✓ almost no vibration
- ✓ optimised gear system
- ✓ more cutting power

### **Good and approved:**

- high-performance motor
- light weight, ca. 1025 g
- very handy because of ergonomic design  
> Ø 51-53 mm thin  
> 28,5 cm short
- one-hand operation
- overcharge switch
- top quality blades (can be resharpened very often!)

### **Cattle clipper**

with standard blades 86863 and 86862 for cattle, dogs and Iceland ponies; cutting height ca. 3 mm

89500.000

#### **Standard - upper blade 22 teeth, single**

86863.000

#### **Standard - lower blade 18 teeth, single**

86862.000



86863.000



86862.000

#### **Coarse clipping - upper blade 10 teeth, single**

86853.000

#### **Coarse clipping - lower blade 11 teeth, single**

86852.000

cutting height 3 mm



86853.000



86852.000

#### **Post-clipping - upper blade 17 teeth, single**

86833.000

#### **Post-clipping - lower blade 24 teeth, single**

86832.000

cutting height 3 mm



86833.000



86832.000

#### **Udder clipping - upper blade 17 teeth, single**

86833.000

#### **Udder clipping - lower blade 35 teeth, single**

86844.010

cutting height 1 mm



86833.000



86844.010

#### **Udder clipping - upper blade 17 teeth, single**

86833.000

#### **Udder clipping - lower blade 35 teeth, single**

86845.010

cutting height 1/10 mm



86833.000



86845.010



## Electric 2000 PLUS - Horse clipper -

### **NEW:**

- ✓ **best silent running (approx. 75 dB)**
- ✓ **almost no vibration**
- ✓ **optimised gear system**
- ✓ **more cutting power**

### **Good and approved:**

- high-performance motor
- light weight, ca. 1025 g
- very handy because of ergonomic design
  - > Ø 51-53 mm thin
  - > 28,5 cm short
- one-hand operation
- overcharge switch
- top quality blades (can be resharpened very often!)



### **Horse clipper**

with standard blades 86833 and 86872  
cutting height 3 mm

89503.000

#### **Standard - upper blade 17 teeth, single**

86833.000

#### **Standard - lower blade 28 teeth, single**

86872.000



86833.000



86872.000

### **Post-clipping - upper blade 17 teeth, single**

86833.000

### **Post-clipping - lower blade 35 teeth, single**

86842.000

cutting height 3 mm



86833.000



86842.000

### **Adjustment of blades on the Electric 2000 PLUS - Cattle and horse clipper -**

- 1) Remove the old blades by unfastening the regulating nut until the screw is screwable and easy to pull out. Then remove the blades. Please pay attention to the regulating nut, that it does not loosen the screw to avoid the losing of single spare parts.
  - 2) Take a brush for cleaning the clipping head carefully.
  - 3) Adjust the eccentric block in such a way, so that it is possible to put in the guide of the upper blade easily. Please make sure, that the surface of the blades is totally clean.
  - 4) Put in the lower blade and adjust the screw, so that the screw can hold the blades.
  - 5) Turn the regulating nut until you recognise the first resistance and afterwards again 1 1/4 of a turn (Please see the marking on the regulating nut)
- > The clipper is now ready to use! It is also important to oil the blades during the clipping process several times in switched-on mode.

**Each cattle and horse clipper, as well as sheep shearing machines are always delivered complete including blades, oiler and instruction book in a strong carrying case.**

## Electric 2000 PLUS - Spare parts - for the clipper for cattle and for horses -



### **Complete head for clipper**

with blades for cattle 86862 and 86863

89500.600

without blades

89500.800



### **Complete head for clipper**

with blades for horses 86872 and 86833

89503.600

### **Note:**

The heads for the clippers for cattle and for horses are no longer interchangeable with the heads of the sheep shearing machines!



### **Oil**

120 ml bottle

89500.650



### **Oil**

1 litre canister

87500.000



### **Brush**

strong and large, for cleaning the blades

89410.000

strong and small, for cleaning the blades

89600.410



### **Eccentric block**

single

89100.110

5 pieces

89500.110

### **Repairing and resharpening:**

If your cattle or horse clipper or your sheep shearing machine should be repaired or the blades have to be resharpened, please send us your clipper/shearing machine or just the blades. Add a small note describing which part has to be repaired or which irregularities you have noticed and we will do this work for you! If you would like to get an estimation of costs, please note this as well as your contact details, like address and telephone number! Our address is as follows:

**H. Hauptner und Richard Herberholz GmbH und Co. KG**  
**Kuller Str. 38-44**  
**42651 Solingen**

## Spare parts

<b>Screen filter</b>	89100.960
<b>Screw</b>	89100.970
<b>Toothed wheel M / Steel hub</b>	89500.080
<b>Set of screws and washers</b>	89500.610
<b>Shearing head complete, without blades</b>	89500.800
<b>Lower comb guide</b>	89100.030
<b>Spare profile unit</b>	86831.020
<b>Spiral clamping pin to 86831.020</b>	89500.020
<b>Regulating nut</b>	89500.050
<b>Compression spring</b>	89500.030
<b>Guide screw</b>	86831.040
<b>Eccentric block</b>	89100.110
<b>Eccentric block, 5 pieces</b>	89500.110

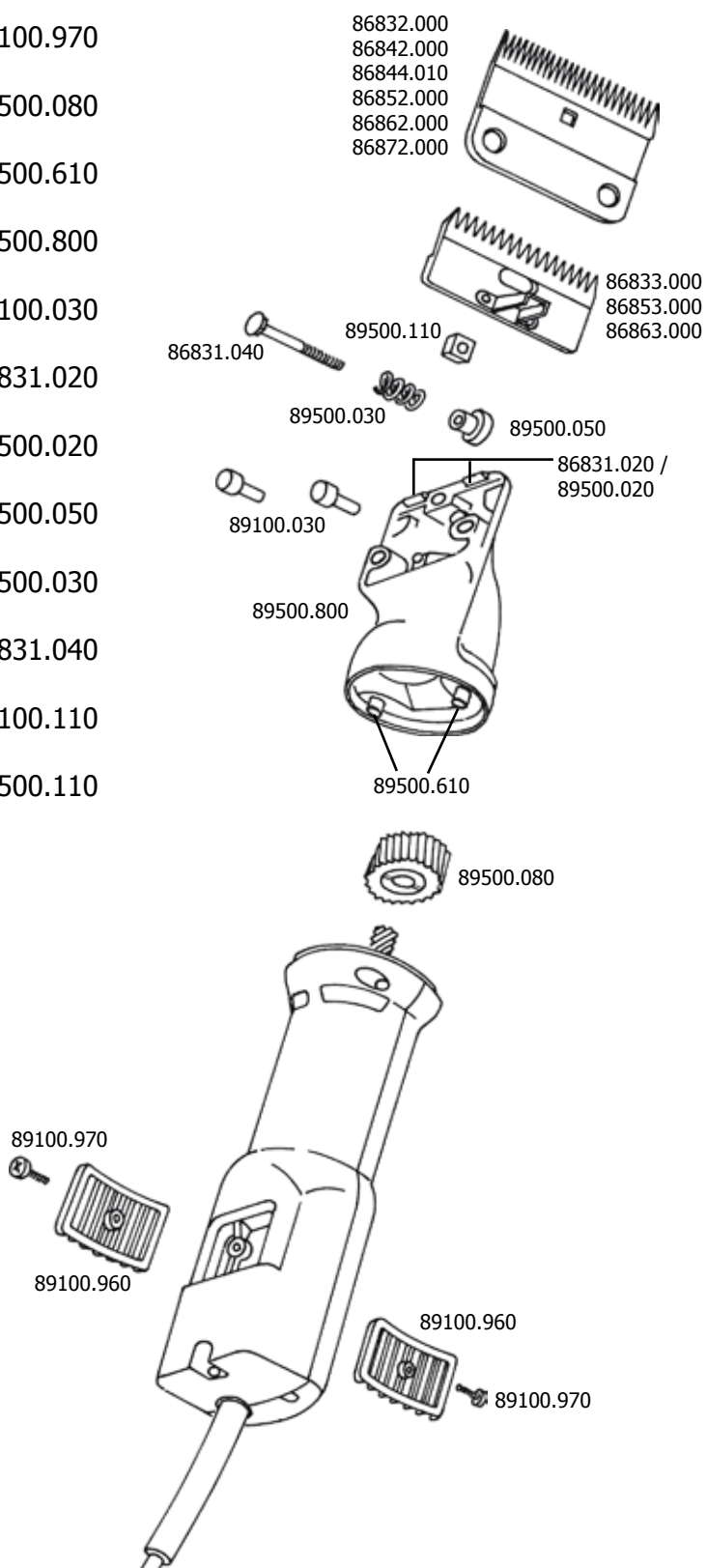

**Electric 2000 s PLUS - Sheep shearing machine -**



**NEW:**

- ✓ best silent running (approx. 75 dB)
- ✓ almost no vibration
- ✓ optimised gear system
- ✓ more cutting power

**Good and approved:**

- high-performance by permanent energised motor, 230 volt
- light weight, ca. 1200 g
- very handy because of ergonomic design  
> Ø 51-53 mm thin  
> 31,5 cm short
- one-hand operation
- overcharge switch
- 4700 blade movements
- top quality blades (can be resharpened very often!)

**Sheep shearing machine**

with standard blades 87279 and 87268

89600.000

**Standard - upper blade 4 teeth, single**

87279.000

**Standard - lower blade 13 teeth, single**

87268.000

cutting width 76 mm



87279.000



87268.000

**Sheep shearing machine for cattle clipping**

**!!!NEW!!!** with 18-teeth cattle blade

89602.000

**Standard - upper blade 4 teeth, single**

87279.000

**Cattle blade - lower blade 18 teeth, single**

87270.000

cutting width 76 mm



87279.000



87270.000

**For professional clipping:**

**Standard - upper blade 4 teeth, single**

87279.000

**Profi sheep - lower blade 13 teeth, single**

87272.000

cutting width 90 mm

**Complete shearing head**

with blades for sheep

89600.600

without blades

89600.800

**Screwdriver**

only suitable for the sheep shearing machine

89400.000



87279.000



87272.000



## Spare parts

<b>Screen filter</b>	89100.960
<b>Screw</b>	89100.970
<b>Toothed wheel M / Steel hub</b>	89500.080
<b>Cap for regulating nut</b>	89600.660
<b>Regulating nut</b>	89600.750
<b>Fitting screw</b>	89600.090
<b>Pressure sleeve complete</b>	89600.840
<b>Double spherical head bolt</b>	87200.790
<b>Set of screws and washers</b>	89600.610
<b>Screwed bush</b>	89600.630
<b>Heat isolation cap (couple)</b>	89600.040
<b>Shearing head without blades</b>	89600.800
<b>Spherical screw</b>	89220.100
<b>Eccentric shaft Z3</b>	89600.060
<b>Blade retaining screw</b>	89230.800
<b>Cover</b>	89600.020
<b>Screw M3x16 for 89600.020</b>	89600.030
<b>Fork guide carrier</b>	89600.180
<b>Eccentric ball</b>	87200.050
<b>Fork finger, right</b>	89220.190
<b>Fork finger, left</b>	89220.200
<b>Retaining spring</b>	87200.760
<b>Fork clip</b>	89230.210

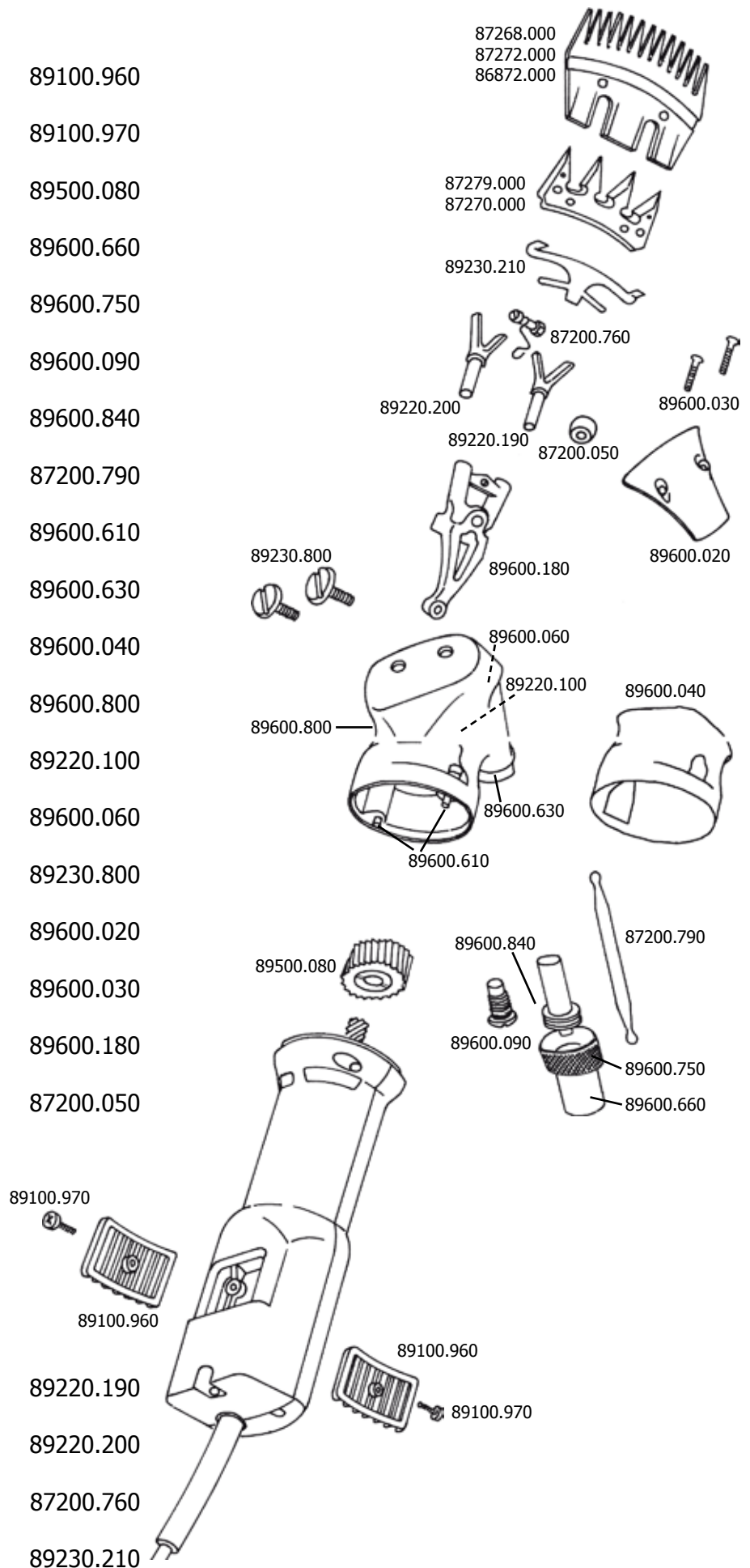

## Grinding outfits



### **Grinding outfit (double sided)**

for blades for sheep, cattle, horses and dogs, high-performance motor, 230 volt, complete with 2 m lead, grinding disc 88193.010, wooden blade holder 88196.200 and 1 rod of emery, fine 88198

89251.000

### **Grinding outfit (one sided)**

for blades for sheep, cattle, horses and dogs, high-performance motor, 230 volt, complete with 2 m lead, schuko plug, grinding disc 88193.010, wooden blade holder 88196.200 and 1 rod of emery, fine 88198

89253.000

### **Motor for the grinding outfit**

single, 230 volt, 0,37 kW, 1.200-1.400 rotations/min

89250.210



### **Grinding disc**

for blades for sheep, cattle, horses and dogs, one sided, without grooves, 28 cm Ø, 19 mm bore diameter

88193.000

### **Grinding disc**

for blades for sheep, cattle, horses and dogs, double sided, without grooves, 28 cm Ø, 19 mm bore diameter

88193.010



### **Wooden blade holder**

for holding blades for cattle, horses and dogs during the grinding process

88196.200



### **Wooden blade holder**

for holding blades for sheep during the grinding process

88664.200



### **Emery rod**

following our approved Hauptner-Herberholz-composition fine, for regrind

88198.000

coarse, for pre-grinding

88199.000

## **Starting the grinding outfit**

First of all, please read the safety instructions carefully. Please fix the grinding unit on a desk with strong screws. After fixing the grinding disc to the unit secure it with the screws included. Finally assemble the protection device above the grinding disc. Firstly bring some of the emery on to the wheel. Hold the emery rod on to the rotating wheel and move it so that the whole surface will be covered with emery. Before sharpening the blade fix the lower blade on to the wooden holder. Go parallel with the teeth showing to the earth on to the rotating wheel and move it back and forward from the outer edge of the wheel to the center, using the full surface. Move the blade in one straight line. It is necessary to grind as long as all blank parts on the lower blade have disappeared. The grinded side must show fine, symmetrical lines going from the back to the teeth. When the blade is ready, lift it carefully from the rotating wheel, by lifting firstly the teeth, so that the rotating wheel cannot damage the wheel. Now the same procedure has to be done with the upper blade. Please use the corresponding holder. The teeth must show to the bottom and use the full surface of the grinding disc going in one line back and forward.

## Animal clipper

### **Animal clipper PRO Series**

can be used with or without cord for maximum convenience

Pro Series clipper with blade, 4 attachment combs (10, 13, 19 and 25 mm), oil, cleaning brush, scissors and instruction

- cutting width approx. 46 mm
- weight approx. 230 g
- a fully charged clipper will deliver a minimum of 20 minutes of continuous trimming
- input power (power supply) 230 volt, 50 Hz, 13 watt



88177.000



### **Optional accessory:**

Not included in delivery!

### **Attachment combs**

10 mm, cutting height 0,9 mm

88177.010



### **Attachment combs**

13 mm, cutting height 2,0 mm

88177.020



### **Attachment combs**

19 mm, cutting height 3,0 mm

88177.030



### **Attachment combs**

25 mm, cutting height 5,0 mm

88177.040



## Professional animal clipper

### Professional animal clipper ARCO



- strong with 2 battery packs
- professional shearing head for quick change
- with quick cleaning function
- integrated cutting length adjustment with 5 positions (0,1 - 3 mm)
- The special geometry of the blade set allows a constant hair length, independently of the operating angle
- long lasting battery packs because of innovative battery technology
- Battery-charging station with LED-controlling lamp and 1 hour fast charging system
- Non-stop, efficient operation due to two exchangeable battery packs, battery operating time of up to 100 min.
- Always ready because of 2 battery packs
- Power source: 220-240 V, 9 watt
- Weight ca. 270 g
- Precision-ground, stainless steel blade set for even longer service life, easy removal without tools for comfortable and easy cleaning



Including accessories:

- 2 battery packs
- 4 blades (3, 6, 9 und 12 mm)
- battery charging station, cleaning brush and a bottle of oil

88176.000

#### **Blade set**

single

88176.010

#### **Battery pack**

single

88176.020

#### **Type**

Cutting system  
Cutting width  
Cutting length  
Drive  
Power source  
Battery charging time  
Fully charged operating time  
Dimensions  
Weight

#### **Professional animal clipper with quick release battery**

Professional interchangeable blade set  
46 mm  
0,7 - 3 mm  
Efficient DC motor with sound proofing  
220-240 V, 50-60 Hz  
100 minutes quick charge  
up to 100 min.  
170 x 50 x 50 mm  
270 g



## andis animal clipper

### andis „model AGC“ with motor in the handle

- professional animal clipper with universally usable blades
- conceived for professional use
- also usable for sanitary preparation
- powerful motor designed for heavy-duty use and long life
- extremely cool and quiet operation - noisy fan and air vents are not needed
- detachable blades for easy changing and cleaning
- maintenance free - no oiling or greasing of internal parts is needed
- this system includes: clipper, blade set (upper and lower blade) (88422), clipper oil and instructions



88400.000

### andis „Modell AGR+“ Akku-Maschine

- equipped with a unique charging system that charges battery to maximum performance every time
- no overcharge possible
- clipper will run continuously for one hour with a fully charged battery pack
- charging time is also one hour or shorter
- battery pack can be recharged separately from clipper
- detachable blades for easy changing and cleaning
- this system includes: rechargeable clipper, blade set (upper and lower blade) (88422), clipper oil and instructions (see picture below)
- 40 watt













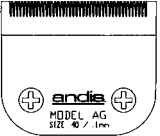
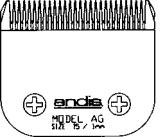
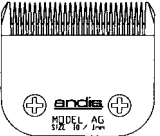
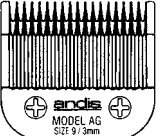
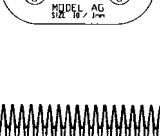
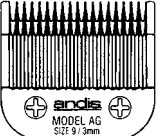
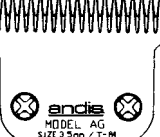
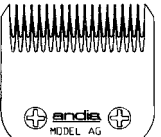

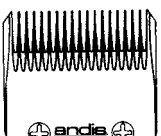
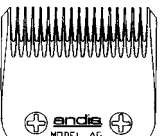
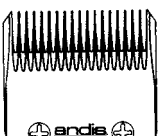
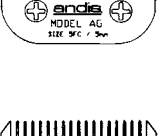
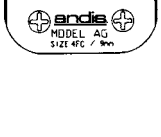
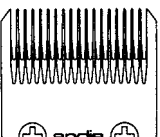
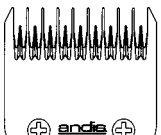
88410.000

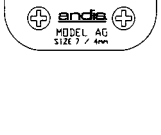
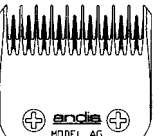
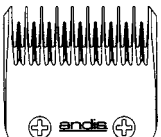
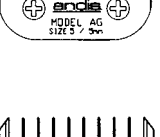
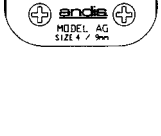
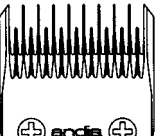
### **Battery pack** for „Model AGR +“

88450.000

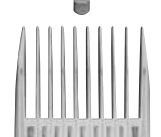
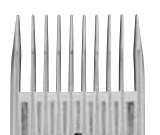

## andis **Blades for animal clippers**

		<b>Surgical cut, very close cutting</b> cutting height 0,25 mm / 1/100", size 40	88420.000
		<b>Medium cut</b> cutting height 1,2 mm / 3/64", size 15	88421.000
		<b>Medium cut, very close cutting</b> cutting height 1,5 mm / 1/16", size 10	88422.000
		<b>Medium cut</b> cutting height 2 mm / 5/64", size 9	88425.000
		<b>Extra wide medium cut</b> cutting height 2,4 mm / 3/32", size T84	88429.000
		<b>Finish cut</b> cutting height 3,2 mm / 1/8", size 7	88430.000
		<b>Finish cut</b> cutting height 6,3 mm / 1/4", size 5	88431.000
		<b>Finish cut</b> cutting height 9,5 mm / 3/8", size 4	88432.000
		<b>Finish cut</b> cutting height 13 mm / 1/2", size 3	88433.000
		<b>Skip tooth</b> cutting height 3,2 mm / 1/8", size 7	88440.000
		<b>Skip tooth</b> cutting height 6,3 mm / 1/4", size 5	88441.000
		<b>Skip tooth</b> cutting height 9,5 mm / 3/8", size 4	88442.000
		<b>Finish cut</b> cutting height 13 mm / 1/2", size 3	88443.000
		<b>Set of 4 piecessnap on combs</b> available for 8422, size ca. 3 mm, 6 mm, 9 mm and 13 mm	88449.000
			
			

## Hand clippers for cattle, horses, sheep and small animals

### **Clipper, with extra long teeth**

cutting width ca. 45 mm, for sheep

85250.000

upper blade

85250.010

lower blade

85250.020

screw

85250.040

### **Clipper „Hauptner-Perfect“, coarse blades**

ca. 3 mm cutting height, cutting width 53 mm, for cattle

85280.000

upper blade

85280.010

lower blade

85280.020

### **Clipper, extra fine toothed**

ca. 3 mm cutting height, cutting width 55 mm, for dogs and horses

85370.000

upper blade

85280.010

lower blade

85370.020

### **Clipper, fine toothed**

ca. 2 mm cutting height, cutting width 45 mm, for dogs

85380.000

upper blade

85380.010

lower blade

85380.020

### **Manual clipper „Lilliput“**

with thumb backing, particularly for head and paw clipping, cutting width 25 mm, for dogs

85392.000

upper blade

85392.030

lower blade

85392.040

### **Manual clipper „Lilliput“**

with thumb backing, particularly for head and paw clipping, cutting width 30 mm, for dogs

85393.000

upper blade

85392.030

lower blade

85393.040

### **Fetlock scissors**

strong model, forged, 18 cm, for horses

85200.000

### **Clipper - Professional quality -**

with straight handles, blade 14 cm, for sheep

85350.000

### **Clipper - Professional quality -**

with curved handles, blades 14 cm, for sheep

85351.000



## Hair scissors

Our hair scissors are made only of high quality, ice-tempered, stainless steel marked Solingen



**Hair scissors, extra fine tothing on one side**  
curved, 19 cm, stainless

72321.000



**Hair scissors, extra fine tothing on one side**  
curved, 16,5 cm, stainless

72324.000



**Hair scissors, extra fine tothing on one side**  
curved, 16,5 cm, with rounded tips, nickel-plated

72327.000



**Hair scissors, extra fine tothing on one side**  
straight, 19 cm, stainless

72322.000

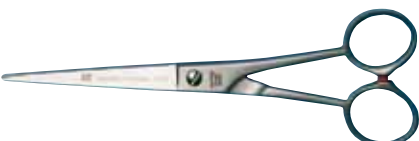

**Hair scissors, extra fine tothing on one side**  
straight, 16,5 cm, stainless

72325.000



**Hair scissors, extra fine tothing on one side**  
straight, 21 cm, with finger hook, stainless

72326.000



**Thinning scissors**  
straight, 25 teeth, 16 cm, nickel-plated,  
tothing on both sides

72330.000



**Thinning scissors**  
straight, 25 teeth, 16 cm, nickel-plated,  
tothing on one side

72331.000



**Hair scissors for dogs**  
11,5 cm, stainless, extra fine tothing

72332.000



**Hair scissors for dogs**  
14 cm, stainless, extra fine tothing

72336.000

## Udder care and control

### **Udder gel**

green, 1000 ml, high quality skin care gel, quick absorbing with cooling effect, little greasing and especially usable for prophylaxis (mastitis) - frequently rubbing and massaging will activate the self-healing process on difficult animals.

No waiting time, if there are small udder problems, because the milk can be directly delivered to the creamery (see instructions for cell determination)

Medisol-salve formulation does not consist of any antidegradant - therefore good skin kindness

96400.000



### **Milker grease**

white, for the daily protection and care of animals and the udder before the milking process, for making the udder and the teats soft and smooth to minimise the exposure while using the milking machine, 1000 ml

96408.000



### **Citro udder ointment**

a bit of acid salve formulation with a high percentage of valuable plant extracts. This animal skin protection is used by milk producers, especially if there are skin problems or outer injuries of the udder or teat. It regenerates the acid acceptance of the skin, 1000 ml

- also suitable for human skin care -

96405.000



### **Milking cup**

made of coloured plastic, with black control inset, 1 l

96300.000



### **Indicating paper**

for udder control, 20 pieces

65300.000



### **Hauptner Test liquid**

Spray bottle, 1 l, sufficient for ca. 100 tests uncoloured, for black test bowls

96101.000

blue, for white test bowls

96101.500

Canister, 5 l, sufficient for ca. 500 tests uncoloured, for black test bowls

96105.000

blue, for white test bowls

96105.500



### **Hauptner test bowl with 4 testing fields**

black

96100.000

white

96100.500



## Feeding pails and bottle



### **Feeding pail**

made of strong and resistant plastic material, cold-resistant - unbreakable, 100% acid-proof, food safe, for calves and lambs, 8 l content, two sides flattened, without accessories

70600.000

### **Valve**

70601.000

### **Rubber sucker for calves, white**

70602.000

**Rubber sucker for lambs** (suitable for feeding pail 70600 and feeding bottle 70615)

70603.000

**Metal holder** for feeding pail 70600

70604.000



### **Feeding pail**

made of strong and resistant plastic material, cold-resistant - unbreakable, 100% acid-proof, food safe, for lambs, 8 l content, complete with holder, 5 rubber suckers and 5 valves

70610.000



### **Feeding bottle**

for lambs, complete with screwable sucker, 1 l content

70615.000

### **Rubber sucker, red**

70603.000



### **Feeding bottle**

for calves, complete with screwable sucker, 2 l content

70626.000

### **Rubber sucker, white**

70602.000

### **Rubber sucker, red**

70602.980



### **„Leimer`s“-rubber sucker**

for calves

70500.000

## Anti-sucker guard

### Anti-sucker guard

avoids that the cows suck each other dry, there is no disability while feeding, aluminium plate with built-on pins  
69321.000



### Anti-sucker guard „Müller“

- made of elastic plastic material
- adjustable by wing nut
- this safe fastening avoids the loosening of the anti-sucker guard
- available in 3 different sizes

small, red - for calves and cows, 9 cm x 7 cm  
69345.000

medium, blue - for cows and cattle, 8,5 cm x 8 cm  
69346.000

large, black - for cattle, 10 cm x 8 cm  
69347.000



### Anti-sucker guards

Calves and cows housed in groups or individual pens often exhibit an abnormal behaviour called cross-sucking. Cross-sucking is defined as one calf sucking the ear, mouth, scrotum, prepuce, tail, udder area or navel of another calf. This type of behaviour can have a negative impact on calf health. The anti-sucker guards fit into the nasal cartilage of the calf/cow. When the animal tries to suck another animal, the protruding spikes will come into contact with the skin tissue causing discomfort and therefore the animal being sucked will move away. Anti-sucker guards do not affect the feed uptake of the animal.

## Milk balance

### Milk balance

fine nickel-plated quality, with adjuster made of brass, the upper scale is for balancing the bucket and the lower scale shows the net weight of the milk

**Milk balance 12/15 kg (27 kg) load-capacity**  
60092.000

**Milk balance 11/12 kg (22 kg) load-capacity**  
60093.000

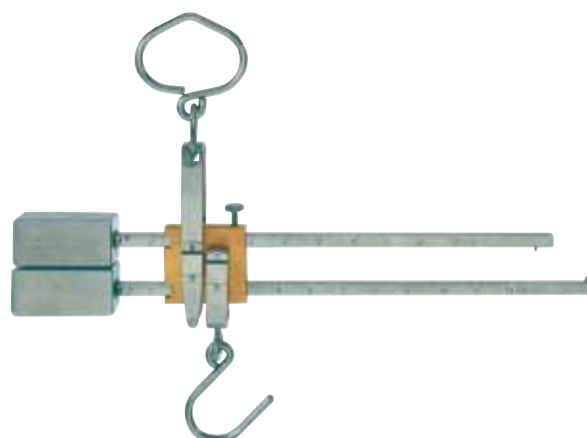



## Measuring sticks

- made of brass and nickel-plated
- hand-made and extremely long-lasting
- individually tested quality
- easy handling
- maintenance free - by correct handling
- complete with instruction

### **Measuring stick**

for horses, walking stick shaped, max. height 180 cm, included the extension piece 10 cm (70190.300), weight 1,3 kg

Measuring range:

height: 96 - max. 180 cm (incl. extension piece)

length: 94 - 168 cm

width: 7 - 80 cm

70190.000

**Measuring legs** - For measuring the height of the withers we only need the upper measuring leg. By spreading the measuring stick the measuring leg becomes visible at the inner side of the square stick. It can be easily drawn out and opened upwardly to such an extent that it is locked in place.

When we draw out the measuring stick further, the second measuring leg becomes visible directly below the first measuring leg. For taking out the second measuring leg, the measuring stick must be drawn to such an extent that the measuring leg is completely free. Now it has to be pushed a little in an upward direction, so that it is released from the support. Then the measuring leg is inserted in the appropriate reception support at the upper round end of the measuring stick, and is screwed tight.

**Measurement of height** - Accurate results of measurement are only to be attained in vertical position of the measuring stick. When measurements are made on soft subsoil the point at the end of the measuring stick gets approx. 1,5 cm deep into the soil. However, this has already been taken into account and has no importance. When measurements are made on hard subsoil where the point cannot dip in, it should be taken into account that we must add 1,5 cm to the measurement that we have made.

**Extension piece** - Before the enclosed extension piece can be screwed on the measuring stick, the point at the end of the measuring stick has to be removed and screwed on the extension piece. In all measurements we have to take into account that we must add 10 cm to the determined value, when measuring on soft subsoil, and 11,5 cm when measuring on hard subsoil.

**Measurement of lengths and breadths** - For the determination of measurements of lengths and breadths there are special scales on the square rod of the measuring stick from which we can read the appropriate values.



### **Measuring stick**

for horses and cattle, for measuring the withers height, measuring leg can be folded away into the stick, weight 1,6 kg, height 105 - 190 cm, nickel-plated

70195.000

The height of a horse can be determined with a measuring stick. The measuring stick should be put on the base of the neck (at the highest point of the back - withers). The measuring would be from the bottom to the withers. With this height you will get the hands high.



## Measuring sticks

### Measuring stick

for cattle, with water-level, weight 2,3 kg, nickel-plated

- Easy replacement of spare parts -

Measuring range:

height: 3 - 115 cm und 120 - 218 cm

length and width: 5 - 214 cm

70275.000

### Upper measuring leg, stainless

70275.310

### Lower measuring leg, stainless

70275.330



### Measuring stick

for sheep and dogs, for measuring the withers height, very stable design with metal base, weight 2 kg, height 4 - 102 cm, nickel-plated,

stainless measuring leg

- Easy replacement of spare parts -

70285.000



## Measuring tapes

### Measuring tape

in strong metal pocket case, for measuring the height and width, for all kinds of animals, with water-level and telescopic measuring arm, measuring between 8 - 300 cm, weight 220 g

70300.000

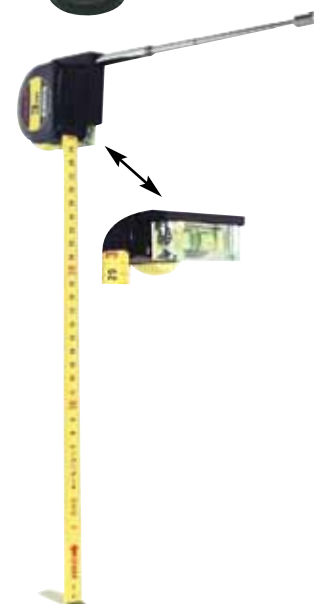

Measuring tapes can be used to estimate the weight of pigs and cattle by measuring the girth.

### Measuring tape

on metal holder, measuring range up to 300 cm, weight 40 g

70082.000



### Measuring tape

with automatic roll-up, property of tape unsurpassed (crease-resistant), 250 cm long, weight 60 g

70430.000



## Curry combs and brushes



### **Curry comb - Coat King**

for detangling, dematting and trimming, for horses, extra fine, for all normally coated horses, 1,5 mm gap, 60 special blades

68290.000

### **Curry comb - Coat King**

for detangling, dematting and trimming, for horses, medium, for very heavy coated horses like Iceland ponies, 3,5 mm gap, 30 special blades

68291.000



### **Curry comb for horses and cattle**

with wooden handle, in 8 rows, metal, 10 x 11,5 cm

68301.000



### **Curry comb for horses and cattle**

with wooden handle, in 8 rows, metal, 10 x 11,5 cm

68305.000



### **Curry comb**

with plastic handle, tooting on both sides, head revolving about 180°, bilaterally usable and flexible, 10,5 x 23 cm

68306.000



### **Curry comb for horses and cattle**

with plastic handle, 12,5 x 17 cm

68340.000



### **Curry comb**

plastic material, with 3 tooting rows, wave shaped, adjustable hand loop, 10 x 16,5 cm

68303.000



### **Curry comb**

plastic material, with adjustable hand loop, 10 x 25 cm

68307.000



### **Curry comb**

with horsehair (mixed), 21,5 x 10 cm

68313.000

## Mane combs

### **Mane comb**

aluminium, 13 teeth, 11 x 5,5 cm

68260.000

### **Mane comb**

simple pattern, 24 teeth, 21,5 x 4,8 cm

68482.000

### **Mane trimming knife**

with wooden handle, fold-up design, blade 8 cm long, nickel-plated, total length 19 cm

68511.000

### **Sweat scraper**

with wooden handle, brass sheet and rubber lip, 20 x 22 cm

68320.000

### **Sweat scraper**

with flexible, toothed metal sheet, one hand or two hands usable, 69 cm

68321.000

## Brushes and curry combs for dogs and cats

### **Brush with angled steel bristles**

for dogs and rabbits, 8 x 4 cm

68500.000

### **Combination dog brush**

with steel and plastic bristles, brush area 9 x 4,5 cm

68503.000

### **Tangle removing brush**

for dogs and cats, with curved steel wire on one side and rigid bristles on the other side, brush area 10 x 6 cm

68505.000

### **Tangle removing brush**

for dogs and cats for removing dead and tangled hair, 8 x 7 cm

68506.000

### **Tangle removing comb**

razor-sharp teeth remove soft knots and felted balls from every coat, without picking and dragging, 18 cm - reversible also for left-handed users -

68485.000

blade spare part set for 68485

68485.010

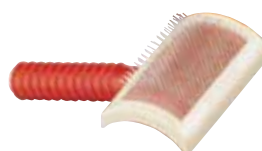

## Trimmer



### **Trimmer „Flamang Special I“**

for West-Highland-Terrier and all similar coated breeds,  
with short teeth for top coat, 13 cm, stainless,  
for right-handed users

68515.000



for left-handed users

68517.000



### **Trimmer „Flamang Special II“**

for West-Highland-Terrier and all similar coated breeds,  
with long teeth for the undercoat, 13 cm, stainless,  
for right-handed users

68516.000



for left-handed users

68518.000



### **Trimmer „Hauptner trim“**

extra coarse toothed, for the upper coat, for trimming  
larger areas of the coat, particularly for all large and wire-  
coated breeds as Airdale etc., 13 cm, stainless  
for right-handed users

68530.000



for left-handed users

68531.000



### **Universal-Trimmer**

13 cm, stainless  
for right-handed users

68532.000



for left-handed users

68533.000



### **Trimmer „Real“**

with plastic handle, 14,5 cm, stainless  
for right-handed users

68510.000



for left-handed users

68520.000



### **Trimmer „english model“**

with plastic handle, 15,5 cm, stainless

68513.000



### **Double Fleecing comb**

with metal handle, fold-up design, nickel-plated, 17 cm  
- particularly suitable for terriers -

68512.000



### **Coat-King**

for stock-haired and longhaired dogs as well as for Terriers  
for finishing, extra fine, 20 special sharpened blades, PVC-  
coated handle

68508.000

## Nail cutters and scissors

### **Nail cutter**

for small and medium-size breeds, 13 cm, nickel-plated  
42581.000



### **Nail cutter**

for all breeds, with cutting flanks curved inwards stops  
nails from slipping, 13 cm, nickel-plated  
42590.000



### **Nail cutter with end stop**

to limit the length of nails cut off, for small and medium-  
size breeds, 14 cm, nickel-plated  
42591.000



### **Nail cutter**

for all breeds, strong model, 16 cm, stainless steel  
42592.000



### **Nail scissors**

for cats, 8 cm, nickel-plated  
42595.000



### **Nail care**

Dogs and cats need a regular care of the nails. If this does not happen or if it happens too late, an abnormal behaviour is not avoidable. The natural abrasion is often not enough in today's usual way of animal husbandry of dogs and cates. This has the result that a cutting of the nails in the period of several months is absolutely necessary.

The nail cutter 42581.000 has a punching tool for taking the nails. The cutting edge, which slides over the punching tool and it effects an accurate cut. The advantage of this model is, that the cutting depth is clearly visible. The cutter is not usable for bigger dogs with stronger nails (starting from german shepherd size).

The models 42590.000, 42591.000 and 42592.000 are added with inward curved cutting pieces, so that the nail cannot slip away while cutting. The model 42591.000 has additionally a stopping piece to limit the cutting length.

For dogs with strong and extremely hard nails, we recommend the models 42590.000 and 42592.000. For cats, the nail scissors 42595.000 is the best tool. This model has as well inward curved cutting pieces, so that the nail cannot slip away.

In case of dogs with nails which split, it is advisable to file the cutting surface carefully.



## **Farm equipment**

### **Plastic toolbox**

made of robust plastic, with stowable grip, 50 kg capacity, 55 cm long, 16 cm wide, 14 cm high

26100.000



### **Combi-scissors**

cuts cord, cardboard, cloth, metal plates, leather, flowers, etc., with ergonomic plastic handles, 16,5 cm long, stainless

99648.000



### **Stable thermometer**

measuring range from -17 to +40°C, with marking for horses, cattle and sheep, on robust wooden plate which can be hung up, 6 x 25 cm

47660.000



### **Disposable gloves**

with 5 fingers, sensitive, 85 cm long, pack of 100 pieces

47511.000

### **Disposable gloves (insemination gloves)**

with 5 fingers, sensitive, shoulder-length, 100 pieces in one box

47517.000



### **Disposable protection boots**

with laces, 0,06 mm thick, 43 cm high, clear, pack of 50 pieces

47516.000



### **Protection mask**

against coarse dust of flowers, hay and dung, also suitable for animal care, during spraying of chalk and during the distribution of any animal feed additions etc., 4 g weight, pack of 50 pieces

48500.000

### **Farmer protection mask**

especially developed for agriculture and farming, very comfortable mask, pack of 3 pieces

48810.000



### **Ear plugs**

suit and fitting, safe and soundproof, light as a feather, pack of 2 pieces

48795.000

**You will find more information about animal identification in our special ear tag flyer!**

- Plastic ear tags
- electronic animal identification

...

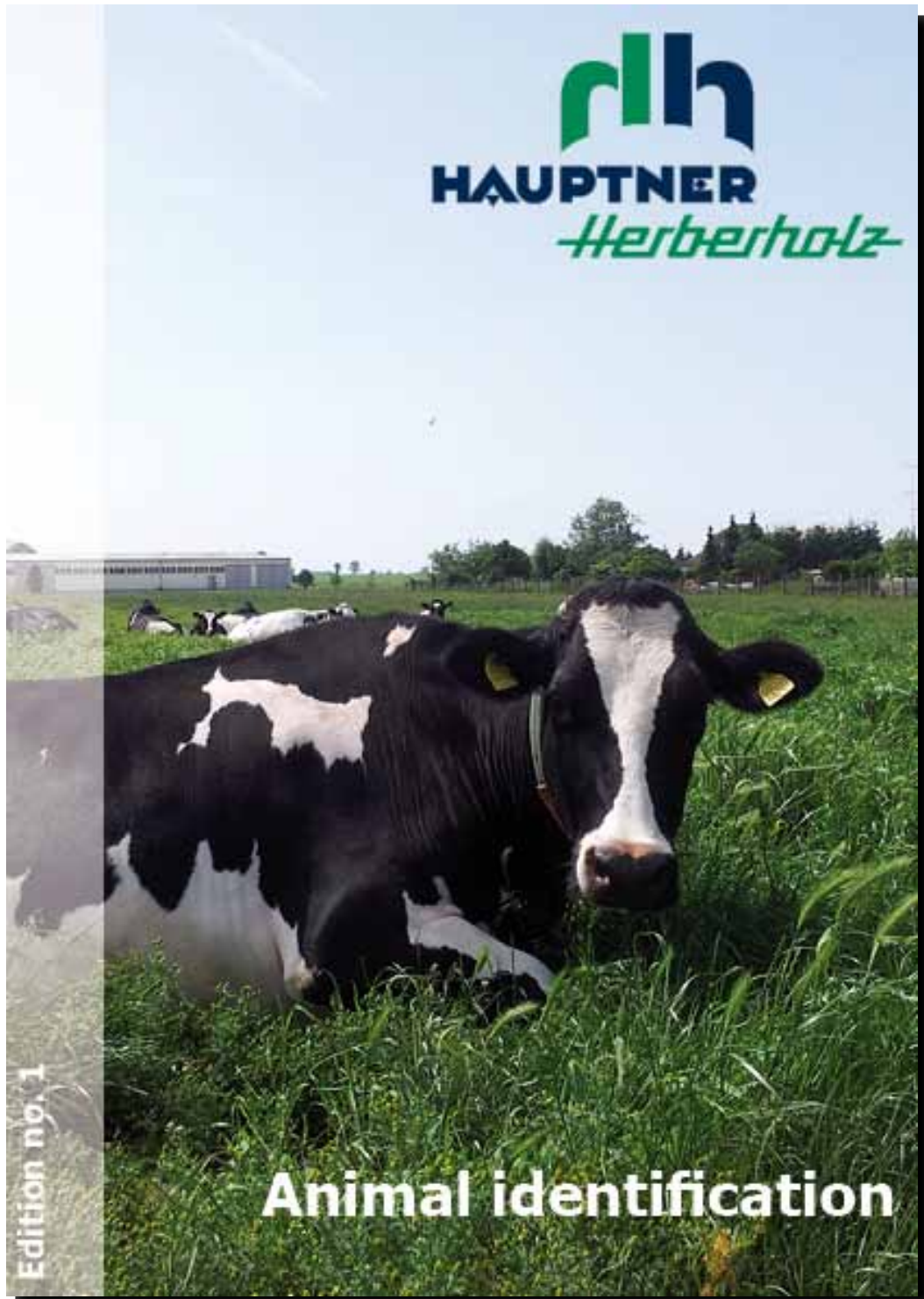

**Please contact us under**

**verkauf@hauptner-herberholz.de or 0049 (0) 212 - 250 1 - 0**

## Brass ear tags for animals

**Supercrotal / Compressan - animal ear tags** are made of brass, made with one piece of brass with protective edges, „tamperproof“ and they are not re-usable.

**Minimum quantity 100 pieces**



### **Supercrotal / Compressan - animal ear tags**

large model, for cattle, marked with current numbers up to 7 spaces on one side and letters up to 5 spaces for letters on the other side, 40 mm long, 12 mm wide, numbered 1 - 1000

72950.020

numbered starting from 1001

72950.201

blank

72950.010

### **Supercrotal / Compressan - animal ear tags**

small model, for sheep, marked with current numbers up to 6 spaces on one side and letters up to 5 spaces for letters on the other side, 35 mm long, 8 mm wide, numbered 1 - 1000

72960.020

numbered starting from 1001

72960.201

blank

72960.010



### **Supercrotal / Compressan - one-hand plier**

for fastening the above ear tags with automatic release for large model

72959.000

for small model

72969.000

## **Applying the Supercrotal animal ear tag**

For applying the Supercrotal ear tag please use the Supercrotal - one hand plier 72959 for the large model and for the small model please use the Supercrotal - one hand plier 72969. The ear should be put opened into the plier (in this step, please do not press on the neck, avoid it by pulling the ear tag into the plier), then the ear has to be placed between the ear tag and then the plier can be closed. Because of the pressure of the plier, the Supercrotal ear tag is pressed through the ear (the ear tag is cutting a hole by itself, because of the sharp edge), automatically riveted and released. You only have to pay attention while applying, that you do not a cartilage band. It is required not to apply these ear tags in midsummer, if possible, because otherwise some small blood drops can attract flies. It is reasonable to apply the ear tags before or after putting them out at feed.

Practically, there is just one work step necessary for applying the Supercrotal ear tags, which is the closing of the plier. Because of this, this system is superior comparing to other systems. Furthermore, the loss rate of the ear tags is very low!



## Brass ear tags for animals

### **Dorital-ear tags**

with round rivet, made of brass, 11,4 mm wide, marked with current numbers up to 7 numbers and with marking up to 5 letters

**Minimum quantity 100 pieces**

blank

73810.010

marked

73810.100



### **Dorital-ear tag - plier**

for fastening the above ear tags with automatic release

73819.000



## For self-stamping of metal ear tags

### **Steel numbers**

5 mm, character height for large and small models of Supercrotal / Compressan - and Dorital-ear tags

Set steel figures, 0 - 9, arabic

73051.000

Steel figures, single

73051.010 - 73051.100



### **Steel letters**

5 mm, character height for large and small models of Supercrotal / Compressan - and Dorital-ear tags

Alphabet steel letter, A - Z

73071.000

steel letter, single

73071.010 - 73071.260



### **Anvil**

large

73043.000



## Durafix® -ear tags for slaughter animals

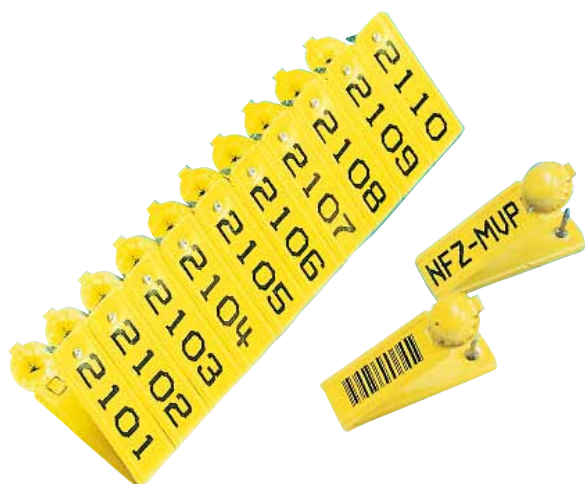

### Durafix®-ear tags

- for temporary marking
- quick and safe application by hand in the ear of the animal
- „tamperproof“, the ear tags will be destroyed, if attempts are made to open them
- approved over decades
- with black printed numbers on one side and letters (up to 6 spaces) or logos etc. on the other side
- wipe- and scratch-resistant marking
- also available with EAN-code

**Minimum quantity 100 pieces**



### Durafix®-ear tags

white, blank or numbered	73780.100
white, numbered 1 - 1000	73780.020
red, blank or numbered	
	73781.100
blue, blank or numbered	
	73782.100
green, blank or numbered	
	73783.100
yellow, blank or numbered	
	73786.100
grey, blank or numbered	
	73789.100

## Ear tags for laboratory animals, rabbits and guinea pigs

### Ear tags for laboratory animals

made of brass, marked with current numbers up to 4 spaces and with space for 3 letters, numbered 1 - 1000	73850.020
numbered starting from 1001	73850.100
blank	73850.100

**Minimum quantity 100 pieces**

### Plier for ear tags for laboratory animals

individually controlled, nickel-plated	73855.000
Spring for the plier	73855.050

### Ear tags for rabbits and guinea pigs

made of brass, with current numbers up to 4 spaces  
These ear tags can be fastened without a plier

<b>Minimum quantity 100 pieces</b>	73865.100
------------------------------------	-----------

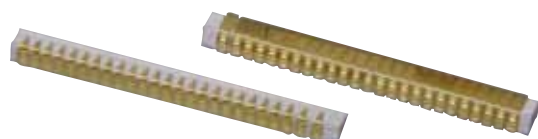

## Chicken wing tags

### Resi chicken wing tags

with consecutive numbering

Minimum quantity 100 pieces

74690.100



## License plates

### Identification tag

for horses, made of high-quality and flexible plastic, yellow, 7 x 8 cm, blank, with 2 slits for fastening the identification tag on to the bracket

72878.000



### Special marker, black

72875.000



### Special marker, black HH

72875.600

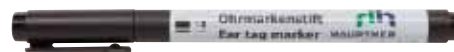

### License plate with official printing

for horses, made of high-quality and flexible plastic, yellow, 8 x 10 cm, 2x printed by laser-method, 20 and 30 mm high, with 2 slits for fastening on the bracket

72905.000

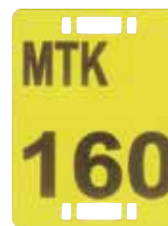

### Official Year-tags

in the official colours

72901.000



## Ear-marking pliers

### Ear-marking plier

small model, 15 cm long, with pointed cutting sign, nickel-plated, for sheep and pigs

72040.000



### Ear-marking plier

with multiple action, 23 cm long, coated, with figure no. 1 Ø 10 mm

72706.000



### Individual figures

figure 1 - 12, single, for ear-marking plier 72706

72708.010 - 72708.120

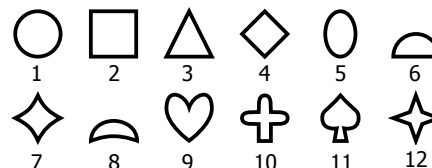

### Punch

with 6 different holes from approx. 3 - 6 mm Ø, 21 cm long, nickel-plated

72210.000



## Marking hammers and Accessories

### Marking hammer model „Prima-Mini“

for letters and numbers with 20 mm character height



3-digit, 1-rowed	71853.000
4-digit, 1-rowed	71854.000
5-digit, 1-rowed	71855.000
6-digit, 1-rowed	71860.000
8-digit, 2-rowed	71864.000
10-digit, 2-rowed	71863.000
12-digit, 2-rowed	71862.000
11-digit, 3-rowed	71861.000
12-digit, 3-rowed	71861.100
13-digit, 3-rowed	71868.000
14-digit, 3-rowed	71868.100

### Numbers

20 mm character height, made of brass, with pointed needles made of stainless steel (plate height 0,3 cm)  
set of numbers

71856.000

numbers, single

71856.010 - 71856.100

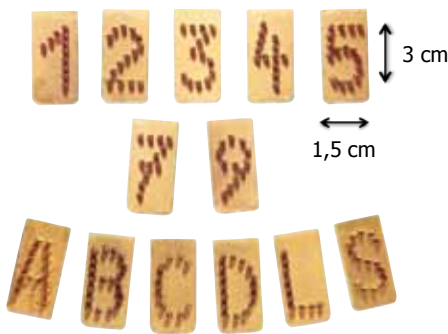

### Letters

20 mm character height, made of brass, with pointed needles made of stainless steel (plate height 0,3 cm)  
alphabet

71857.000

letters, single

71857.010 - 71857.260

### Blank plate

for 20 mm, made of aluminium

71856.320

### Tattooing signs

20 mm character height, 2-digit, simple plate

71857.520

20 mm character height, 2-digit, double plate

71857.620

20 mm character height, 3-digit, double plate

71857.630

### Special tattooing ink

black, non toxic and food safe

1-litre bottle

71858.000

1/2-litre bottle

71858.500

### Ink pad in metal case

in case with handle, 140 x 140 mm

71889.000

spare ink pad, 140 x 140 x 14 mm

71889.010



## Marking hammers and Accessories

### Marking hammer model „Prima-Midi“

for letters and numbers with 30 mm character height  
 3-digit, 1-rowed 71870.000  
 4-digit, 1-rowed 71869.000



### Numbers

30 mm character height, on double plate, with unbreakable needles made of stainless steel set of numbers  
 71872.000  
 numbers, single 71872.010 - 71872.100



### Letters

30 mm character height, on double plate, with unbreakable needles made of stainless steel alphabet  
 71871.000  
 letters, single 71871.010 - 71871.260



### Blank plate

for 30 mm, made of aluminium  
 71872.310



### Tattooing signs

30 mm character height, 2-digit, simple plate  
 71871.520

### Marking hammer model „Prima-Midi“

for letters and numbers with 40 mm character height  
 3-digit, 1-rowed 71873.000  
 4-digit, 1-rowed 71874.000  
 5-digit, 1-rowed 71875.000



### Numbers

40 mm character height, on double plate, with unbreakable needles made of stainless steel set of numbers  
 71876.000  
 numbers, single 71876.010 - 71876.100

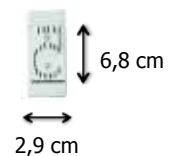

### Letters

40 mm character height, on double plate, with unbreakable needles made of stainless steel alphabet  
 71877.000  
 letters, single 71877.010 - 71877.260

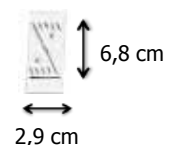

### Blank plate

for 40 mm, made of aluminium  
 71878.000

### Tattooing signs

40 mm character height, 2-digit, simple plate  
 71877.520



**Tattooing pliers**

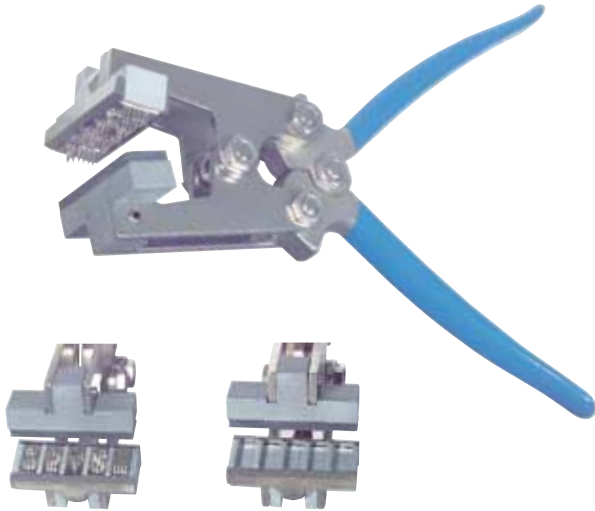

**Tattooing plier**

with multiple action, nickel-plated, with plastic coated handles, excluding accessories, in cardboard box

5-digit, short handles 14 cm, 15 mm character height 71602.000

5-digit, short handles 14 cm, 20 mm character height 71603.000

6-digit, short handles 14 cm, 10 mm character height 71606.000

10-digit, 2 rows, with long handles 19 cm, 10 mm character height 71610.000

12-digit, 2 rows, with long handles 19 cm, 10 mm character height 71612.000

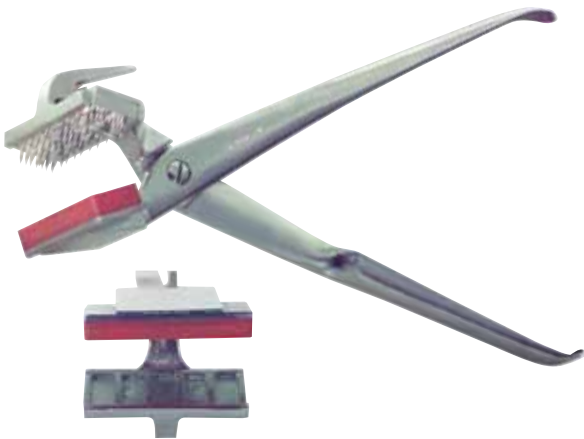

**Tattooing plier**

made of steel, nickel-plated, excluding accessories, in cardboard box

5-digit, for piglets and sheep, 10 mm character height 71061.000

5-digit, for calves, 15 mm character height 71062.000



**Tattooing plier**

made of steel, brilliant-galvanised, excluding accessories, in bag

7-digit, 10 mm character height 71067.000

The tattooing plier no. 71067 has no separated spaces so that you need blank plates no. 71111.310 to fill it up if you tattoo with less than 7 figures

## Tattooing numbers and letters

### Numbers, single, with round needles

10 mm character height	71111.010 - 71111.100
15 mm character height	71112.010 - 71112.100
20 mm character height	71113.010 - 71113.100

### Set of numbers, with round needles, in wooden case

10 mm character height	71111.000
15 mm character height	71112.000
20 mm character height	71113.000

### Double set of numbers, with round needles, in wooden case

10 mm character height	71116.000
15 mm character height	71117.000
20 mm character height	71118.000

### Letters, single, with round needles

10 mm character height	71131.010 - 71131.260
15 mm character height	71132.010 - 71132.260
20 mm character height	71133.010 - 71133.260

### Alphabet, with round needles, in wooden case

10 mm character height	71131.000
15 mm character height	71132.000
20 mm character height	71133.000

### Blank plate

10 mm	71111.310
-------	-----------

### Vertical numbers

half size (2 vertical figures fit into 1 longitudinal space),  
in plastic bag

set of numbers, 10 mm character height	71140.000
set of numbers, 15 mm character height	71142.000
numbers, single, 10 mm height	71140.010 - 71140.100
numbers, single, 15 mm height	71142.010 - 71142.100

### Vertical letters

half size (2 vertical figures fit into 1 longitudinal space),  
in plastic bag

alphabet, 10 mm character height	71145.000
alphabet, 15 mm character height	on request
letters, single, 10 mm height	71145.010 - 71145.260
letters, single, 15 mm character height	on request

### Blank plate

10 mm	71140.310
15 mm	71142.310

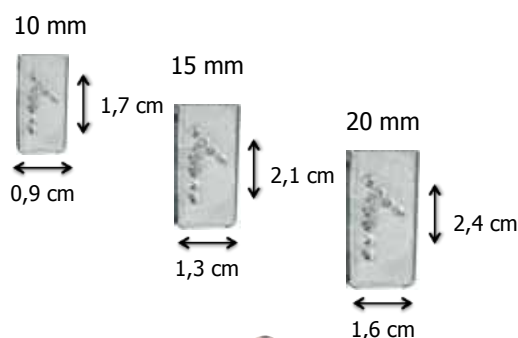

## **Tattooing pliers**



### **Longitudinal tattooing plier**

20 cm long, in cardboard box, excluding accessories, for numbers and letters with 5 mm character height, 7-digit

71479.000

### **Spare rubber plate**

71475.060

### **Spring**

71475.070

### **Longitudinal tattooing plier**

20 cm long, in cardboard box, excluding accessories, for numbers and letters with 7 mm character height, 7-digit

71580.000

### **Spare rubber plate**

71580.060

### **Spring**

71580.070



### **Horizontal tattooing plier**

15 cm long, in cardboard box, excluding accessories, for numbers and letters with 5 mm character height, 4-digit

71514.000

### **Horizontal tattooing plier**

15 cm long, in cardboard box, excluding accessories, for numbers and letters with 5 mm character height, 12-digit

71514.970

### **Spare rubber plate**

71514.080

### **Spring**

71031.040

### **Closing plate, nickel-plated**

71514.050

### **Horizontal tattooing plier**

zinc-plated, excluding accessories, for numbers and letters with 7 mm character height, 10-digit

71068.000

### **Horizontal tattooing plier**

17 cm long, in cardboard box, excluding accessories, for numbers and letters with 7 mm character height, 7-digit

71460.000

### **Spare rubber plate**

71460.060

### **Spring**

71470.050

### **Circular spring**

71031.040



### **Horizontal tattooing plier**

17 cm long, in cardboard box, excluding accessories, for numbers and letters with 7 mm character height, 9-digit, particularly for sheep

71469.000

### **Track with blank plate**

for alteration from 7 mm to 5 mm

71460.590



## Tattooing numbers and letters

### Numbers, single

5 mm character height 71476.010 - 71476.100  
7 mm character height 71471.010 - 71471.100

### Set of numbers, without blank plate, in plastic bag

5 mm character height 71476.000  
7 mm character height 71471.000

### Double set of numbers

with 6 blank plates and tweezers  
5 mm character height, in wooden case 71478.000  
7 mm character height, in cardboard box 71473.000

### Letters, single, without blank plate

5 mm character height 71477.010 - 71477.260  
7 mm character height 71472.010 - 71472.260

### Alphabet, without blank plate

5 mm character height, in wooden case 71477.000  
5 mm character height, in plastic bag 71477.500  
7 mm character height, in cardboard box 71472.000

### Blank plate

5 mm 71476.310  
7 mm 71471.310

### Wooden case

single, for a double set of figures with 5 mm character height or a single set of figures with 7 mm character height

71478.750

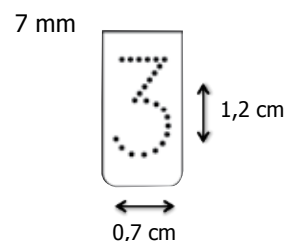
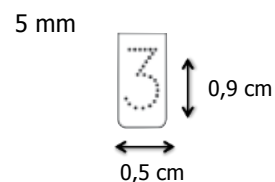



## Tattooing ink

### **Tattooing ink**

in tubes with approx. 60 g content  
black

71492.000

white

71491.000

green

71493.000

### **Tattooing ink**

in boxes with approx. 600 g content  
black

71495.000

green

71497.000

### **Tattooing ink „Rollball“**

liquid tattooing ink, black, approx. 90 g content

71500.000

## Marking spray and sticks

### **Marking spray**

long lasting, especially for pigs, visible for a long time,  
free of CFCs

red, 200 ml

74460.000

red, 400 ml

74465.000

blue, 200 ml

74461.000

blue, 400 ml

74466.000

green, 200 ml

74462.000

green, 400 ml

74467.000



### **Marking sticks „Raidl“**

red

74452.010

blue

74452.020

green

74452.030

black

74452.040

violet

74452.050

yellow

74452.060

white

74452.070



## **Freeze branding**

Durable identification for cattle with liquid nitrogen, gives a clear readable white number on black parts of the skin

### **Freeze branding set**

made of aluminium, with wooden handle, 70 mm character height, from 0 - 9 (6 and 9 = 1 stamp), especially for Friesian-Holstein cows  
All stamps are also available in individual form!

74180.000



### **Cattle identification by freeze branding**

Due to a short reaction time of extremely low temperatures, there will be the reaction of destroyed pigments in the skin. After about 6 weeks time there will grow white hair on black or dark brown skin. This method can be used independently of the age of the animal. The white numbers will stay readable for many years.

Necessary accessories:

- 1 set figures or single ones
- 1 case made of styropor, diameter ca. 40 cm
- 1 pair strong protection gloves
- liquid nitrogen (available at artificial insemination stations for example)

The liquid nitrogen (temperature  $-196^{\circ}\text{C}$ ) has to be filled into the case, so that the metallic area of the stamps is covered. Keep it in the liquid for about 1 minute till the bubbling stopped. Now the stamps have the correct temperature.

Clipp the area where you want to place the numbering short and clean them with water containing some household detergents. Now press the stamps singly for about 30 seconds onto the skin where the number should arise. Take care that the stamp is really pressed to the skin and that no air can come in between.

Attention: Please wear strong protection gloves, as risk of cold brand and acid!

**Please also consider the certain animal protection laws of your country and that the identification by freeze branding cannot be used on red-coloured cows!**

**Please visit our website**

**[www.hauptner-herberholz.de](http://www.hauptner-herberholz.de)**

# **Index**

## **A**

Air conditioned box for liquid semen	64
Animal goads	105
Animal clipper	129-132
Anti-kick bar	103
Anti-sucker guard	137
Anvil	147
Artery forceps	19-20
Artificial insemination accessories	66-67
Artificial insemination instruments	63-64
Artificial vaginas	64

## **B**

Backfat measuring instrument	70
Balling gun	88
Bandages	96
Beech tree tar	116
Berlin casting hobble	103
Biopsy forceps	84
Blades for clippers	122-123
Bleeding needles	55
Blood taking system	58-59
Boar scent spray	63
Bone forceps	21
Bone holding forceps	32
Bone instruments	21
Bone scissors	32
Bow saw	32
Bowel scissors	32
Brass ear tags	146-148
Bron's clamp	103
Brush	124
Buffers	113
Bull leaders	99
Bull rings	98
Burners	31
Butcher-knives	33

## **C**

Calf puller	78-79
Calving chains	76
Calving ropes	75
Cartilage knife	32
Casting hobbles	103
Castration instruments	107-108
Catgut chrom	28
Catgut plain	27
Catheters	84-85
Cautery	31
Centrifuge	95
Cervix cannula	84
Cervix catheter	84
Cervix forceps	86
Cheek spreader	102
Chicken wing tags	149
Chisel	32
Claw cutter	114
Claw instruments	112-116
Claw trimming	113

Clinch cutter	113
Clipper	122-125
Collar	97
Compressor	34
Containers	66
Crease nail puller	115
Crutch	74
Curette	112
Curry combs	140-141

## **D**

Dehorning instruments	109
Dental forceps	14, 120
Dental instruments	119
Descaler forceps	119
Disposable gloves	97
Disposable infusion set	54
Disposable insemination pipettes	
Disposable needles	6754
Disposable protection boots	97
Disposable syringes	54
Dissecting forceps	32
Dissecting knife	32
Docking equipment	108
Dog catcher	104
Dog ear clamps	20
Dorital ear tags	147
Drenchers	51-52
Drenching kit	91
Dressing forceps	13
Dressing holder	10
Dressing scissors	18
Durafix ear tags	148

## **E**

Ear-marking pliers	149
Ear plugs	144
Ear tags (metal)	146-148
Ear tags for laboratory animals,...	148
Ear tags for slaughter animals	148
Electric 2000 PLUS	122-125
Electric 2000 s PLUS	126-127
Electric animal goads	105
Electric cautery	31
Electric dehorner	109
Electric tooth grinder	121
Electrosurgical unit	22
Elplex plastic syringes	50
Emasculator	107
Embryotom	77
Embryotomy instruments	74
Exago	71
Exagyne	73
Examination and operation tables	92
Examination and surgical lamps	93
Extension handle	105
Eye hooks	74
Eyelid forceps	14
Eye needle	26

# **Index**

## **F**

Farm equipment	144
Farrier's set	113
Farrowing forceps	75
Feeding pails and bottle	136
Fixation forceps	14
Flessa needles	80
Flessa vulva sutures	80
Foot ring scissors	18
Forceps	13, 19, 86
Foreign body cage magnets	88
Foreign body detector	8
Foreign body forceps	10
Freeze branding	157
French type straws	65

## **G**

Glide slime	63
Goblets	66
Grinding outfits	128

## **H**

Hair scissors	134
Hammer	32
Hand clippers	133
Hauptner Test liquid	135
HBS 120 universal	22
Heat detectors	60-62
Hoof cutters	115
Hoof hammer	114
Hoof instruments	112-116
Hoof knife set	112
Hoof knives	110-111
Hoof rasps	113
Hoof shoe	114
Hoof tester	114
Hook retractor forceps	12

## **I**

Identification tags for horses	149
Imago	72
Indicating paper	135
Infusion sets	54
Injection extensions	42
Injection sticks	42
Insemination gun	67
Insemination kit	68
Instrument table	92
Instrument tray	94
Intestinal forceps	20
Iris forceps	14
Iris scissors	18
Irrigator	89

## **J**

Janet syringe	50
Jaw spreader	102

## **K**

Kidney dish	94
-------------	----

## **L**

Laboratory ear tags	148
Lamp carrier for specula	83
Lean-Meater	70
License plates	149
Lifting device	103
Ligature scissors	18

## **M**

Magnet stirrer	38
Mane combs	141
Marking hammers and Accessories	150-151
Marking scissors	33
Marking spray and sticks	156
Mayo stand	92
Measure	32
Measuring sticks	138-139
Measuring tapes	139
Meat inspection	33
Meat inspection equipment	38
Meat inspection knife	33
Meat inspection stamps	36
Meat stamping ink	37
MEDICLAMP	81
Microscope	34-35
Milk balance	137
Milk tubes	117
Milker grease	135
Milking cup	135
Mosquito forceps	19
Mouth gags	101-102
MUTO®-Express II syringes	41
MUTO®-Syringes	39-42

## **N**

Nail cutters and scissors	143
Needle for abomasum operation	26
Needle for foreign body operations	26
Needle holder	29
Needles	26, 53-
Nose holders for cattle	57
Nose holders for horses	100
Nose twitches	160

## **O**

Obstetric instruments	74
Obstetric forceps	75
Obstetric hooks	75
Ophthalmoscope	11
Otoscope	10-11
Oven	95

# **Index**

## **P**

Percussion hammers	7
Pig holder	104
Pig nose rings	99
Pig snout rings	99
Plaster shears	18
Plastic collars	97
Plexiglass syringes	49
Pleximeter	7
Pliable balling guns	88
Pocket diagnostic instruments	10
Post mortem instruments	32
Post mortem set	32
PP Overalls	97
Probangs	88-89
Probes	12, 32
Protection mask	144

## **Q**

Quittor knife	112
---------------	-----

## **R**

Re-usable needles	53
Record syringes	48
Resi chicken wing tags	
Restraining instruments	149103-104
Retractors	12, 21
Ring knives	75
Root elevator	119
Rumen holding forceps	86
Rumen juice set	90

## **S**

Saddle horse clincher	115
Saw	32
Scalpel blades	15
Scalpel handles	15
Scissors	16-19
Scissors with inserted carbide cutting edges	19
Self-refilling syringes	47
Serra-emasculator	106
Set for taking out the ruminal juice	90
Sexual organ instruments	84
Sharp spoons	21
Sharpening steel	34
Sharpening stone	112
Sheath of plastic	33
Sheep catching hook	104
Sheep shearing machine	126-127
Shepherd knife	112
Skinning knife	33
Sorting paddle and panel	104
Specula	10
Spine wrench	32
Splinter forceps	14
Stable thermometer	144
Steel numbers and letters	147
Sterilisation equipment	108
Sterimatic	43, 45

Stethoscopes	9
Sticking knife	33
Stomach probangs	88-89
Stomach tubes	88-89
Supercrotal ear tags	146
Supramid	28
Surgical scalpels	16
Surgical scissors	16-17
Suture material	27-28
Suture needles	24-26
Swab catheter	84
Syntena-TT cartridge syringe	46
Syringes	39-44, 46-52
Syringes with metal plunger	50

## **T**

Tattooing ink	156
Tattooing numbers and letters	153,155
Tattooing pliers	152,154
Teat cannulas	117-118
Teat instruments	117-118
Tenotomy scissors	32
Tension line	104
Test bowl for udder control	135
Thawing unit	67
Thermometer	8
Throat catheter	85
Tic forceps	10
Tissue forceps	13-14
Tongue depressor	11
Toolbox	144
Tooth grinder	121
Tooth rasp	121
Tooth scaler	119
Torsion fork	74
Towel clips	12
Trays and dishes	94
Trichino microscope	34
Trichino scissors	33
Trimmer	142
Trocars	87
TT calliper	47
TT needles	46
TT set	46
Tuberculin accessories	46-47
Tuberculin-syringe	44
Tube speculum	63
Tubing mounts	48
Tubular specula	83

## **Index**

### **U**

Udder care and control	135
Udder gel	135
Udder ointment	135
Ultrasound devices	71-73
Ultrasound unit	69
Urinary catheter	84-85
Uterine catheter	84
Uterine holding forceps	86
Uterine pump	86

### **V**

Vaginal mucus stick Vagocheck	84
Vaginal specula	82-83
Venoject blood taking system	58

### **W**

Whelping forceps	75
Wire nose pig holder	104
Wire saw	77
Wound clips	30
Wound treatment	81

# Terms and Conditions of Delivery and Payment

## I. Scope of validity

1. The following terms and conditions of delivery and payment shall apply for all deliveries, performances and offers. In the event that our customer's terms of purchase differ from these, they shall only apply if they have been approved explicitly by us in writing. Acceptance of the goods supplied by us is deemed as acceptance of our terms and conditions.
2. We reserve the unrestricted rights of ownership and copyright utilisation in respect of price quotes, drawings and other documents; they may only be made accessible to third parties upon prior written approval by us.
3. Subsidiary agreements shall only apply if they have been confirmed in writing.

## II. Prices

Our prices are fundamentally ex works plus postage and packing if no other terms of delivery have been agreed. Prices quoted apply fundamentally without insurance. Confirmed prices are based upon the current costs of materials and wages and salaries at the time of order acceptance. We reserve the right to charge those prices that apply on the basis of the current costs of materials and wages and salaries at the time of delivery. Prices are deemed to apply for one item or for the specified quantity plus value-added tax (VAT) at the current rate on the date of delivery. Reductions in remuneration are specified in our current framework agreement and terms and conditions.

## III. Delivery

1. We undertake delivery on behalf of the purchaser with due care and attention, however, we only accept liability for wilful intent and gross negligence. The right of choice of appropriate method of transport also remains with us.
2. Delivery dates shall only apply if they have been confirmed explicitly by us. If the contract has been agreed in writing, confirmation of the delivery date must also be in writing.
3. An appropriate extension to the delivery date must be granted if we are late with a delivery/performance. The purchaser may only withdraw from the contract if the extension to the delivery date expires without effective result. Section 361 BGB remains unaffected in this respect. The delivery deadline commences with the date of despatch of the order confirmation and is deemed to have been observed if the goods have left the works by the end of the delivery period or notification has been given that the goods are ready for despatch. Damages for delay may only be claimed up to the extent of the order value unless the delay was caused by us by wilful intent or gross negligence.
4. Operational disruptions, whether within our business or in that of a supplier, as a result of war, strike, lack of energy, failure of transport means, work restrictions or force majeure, are grounds for exemption from adherence to the agreed delivery deadlines but not for termination of the contractual relationship.
5. The costs for packing and bulk freight will be charged separately insofar as the goods being transported consist of bulky items.
6. Despatch by express freight is fundamentally freight forward.
7. Goods ordered on call ("call-off stock") are to be taken over within the agreed period. If the complete quantity has not been called, remaining amounts which have not yet been called will be despatched to the customer at the end of the agreed period.

## IV. Complaints

1. The guarantee period for production and material faults is 1 year and commences with the day of delivery.
2. Complaints are only permitted within 10 days of receipt of the goods. Claims for hidden defects that cannot be found upon immediate examination may only be made against us if the defect complaint is received by us within 6 months of the goods having left the factory.
3. In the event of justified complaints, we are obliged at our discretion and under exclusion of other claims to rectify the defect and/or provide a replacement delivery, namely to the extent of the order value, unless an assured characteristic or feature is missing or we or our vicarious agents are guilty of wilful intent or gross negligence. The same shall apply in the event of a justified complaint for rectification of the defect or replacement delivery. The purchaser may withdraw from the contract in the event of omitted or faulty rectification or replacement delivery. Liability for subsequent damage resulting from defects remains excluded unless we or our vicarious agents are guilty of wilful intent or gross negligence.
4. In the event of dissatisfaction, the goods may be returned within 10 days insofar as they are still unused. Other than this, goods may only be returned with our explicit agreement. Custom-made items (e.g. embossing in ear tags) are fundamentally excluded from returns.

## V. Payment

1. Deliveries are made fundamentally per cash on delivery or cash in advance unless other delivery terms have been agreed.
2. In the case of sales on invoice, payment is to be made without deduction within 30 days of the invoice date.
3. In the event of overdue payment, default interest shall be payable at the regular interest rate for overdraft facilities. This does not exclude/preclude the assertion of further default damages.
4. The purchaser may only offset or assert a right of retention against our claims if the purchaser's claim is contested or a legally binding title exists.

5. The goods remain our property until complete payment of all demands including any future arising demands. Insofar as the goods are being processed or reworked by the Purchaser, we shall be deemed to be manufacturer pursuant to Section 950 BGB and acquire ownership of the intermediate or end product. The processor is only custodian.

In the event of the reserved goods being combined or processed with other goods not belonging to us, we shall acquire co-ownership of the new item in a ratio of the reserved goods to the other items.

The goods may only be sold in the course of normal and ordinary business transactions and only if claims arising from their resale have not been assigned to third parties beforehand.

Upon signing the purchase agreement with us, claims attributable to the purchaser from the re-sale are deemed to be assigned to us inasmuch and insofar as our goods have been combined or processed with other items. In this case the assigned claims serve as security for us only to the extent of the value of the respective sold reserved item. We will not collect the assigned claim as long as the purchaser fulfils its payment obligations. The purchaser, however, is obliged upon demand to name us the third-party debtors and to notify them of the claim assignment.

6. Pledges or security transfers of the reserved goods or the assigned claims are not permitted. The purchaser shall notify us immediately of any action by third parties in respect of the goods supplied under reservation of ownership or in respect of the assigned claims.

7. If, in the event of delivery abroad, the above agreed reservation of ownership is not permissible with the same effect as under German law, the goods shall remain our property until payment of all our claims from the contractual relationship arising from the sale of the goods and services. If this reservation of ownership is not permissible either with the same effect as under German law, whereas the reservation of other rights to the goods is permissible, we shall be entitled to exercise all such rights. The purchaser is obliged to assist with any measures implemented by us to protect our right of ownership or, in its place, any other rights to the goods.

## VI. Impossibility of performances

If a service or supply incumbent upon us becomes impossible, the fundamental legal principles shall apply subject to the following condition: If impossibility is the result of a fault on our part, the purchaser shall be entitled to demand compensation. The claim for damages by the purchaser, however, shall be restricted to 10 percent of the value of that part of the delivery or performance which cannot be put into suitable operation because of the impossibility. Claims for damages by the purchaser which exceed the aforementioned limit are excluded. This shall not apply, however, insofar as mandatory liability exists in cases of wilful intent or gross negligence. The purchaser's right to withdraw from the contract remains unaffected.

## VII. Place of fulfilment, court of jurisdiction, validity

1. Our company headquarters shall be the place of fulfilment and court of jurisdiction for all claims and legal disputes including those in respect of bills and documents arising from the contractual relationship. Nevertheless, we reserve the right to take legal action at the company headquarters or domicile of the purchaser.
2. In the event that the purchaser is not a fully qualified merchant as defined by the HGB, the location of our company headquarters shall be deemed as agreed as court of jurisdiction for the payment order procedure.
3. The invalidity of one or more provisions hereto shall have no effect on the remaining provisions.
4. Exclusively German law shall apply to all legal relationships arising as a result of the purchase agreement.

## VIII. Data protection

In placing an order, purchasers agree to EDP evaluation of the data contained in their order insofar as this is necessary for order handling and in compliance with existing legislation.

## IX. Packaging Ordinance

We will take back used transport packaging of our company for material recycling or disposal insofar as it is returned to us free-of-charge and in a well-sorted condition. An easier possibility is now provided by the recently created recycling companies which are members of the RESY association and which dispose of all packaging materials which have the RESY mark. Upon request, we will be pleased to provide the address of such a company located in the purchaser's vicinity.

## X. Technical alterations

We reserve the right to undertake alterations to our products in the interest of technical progress.

H. Hauptner und Richard Herberholz GmbH & Co. KG  
Animal identification · Stock Breeding equipment · Veterinary instruments  
Postfach 22 01 34 · D-42629 Solingen  
Kuller Strasse 38 – 44 · D-42651 Solingen  
Tel.: +49(0)212/2501-0 · Fax: +49(0)212/2501-150